

1, 4, 6 CHANNEL ESD PROTECTION DEVICE FOR SUPER-SPEED (UP TO 6 GBPS) INTERFACE

Check for Samples: [TPD1E05U06](#), [TPD4E05U06](#), [TPD6E05U06](#)

FEATURES

- Provides System Level ESD Protection for Low- Voltage IO Interface
- IEC 61000-4-2 Level 4
 - ±15kV (Air gap discharge)
 - ±12kV (Contact discharge)
- IO Capacitance 0.42pF to 0.5pF (Typ)
- DC Breakdown Voltage 6.5V (Min)
- Ultra low Leakage Current 10nA (Max)
- Low ESD Clamping Voltage
- Industrial Temperature Range: -40°C to 125°C
- Easy Straight-through Routing Packages

APPLICATIONS

- HDMI1.4
- USB3.0
- MHL
- LVDS Interfaces
- DisplayPort
- PCI Express
- eSata Interfaces

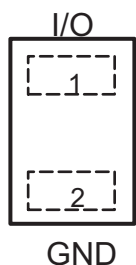
DPY

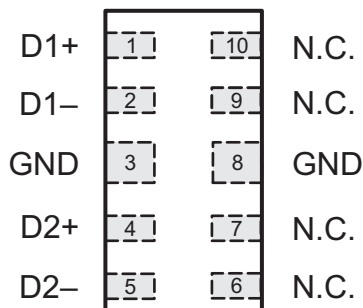
1 mm x 0.6 mm x 0.35 mm
(0.65-mm pitch)

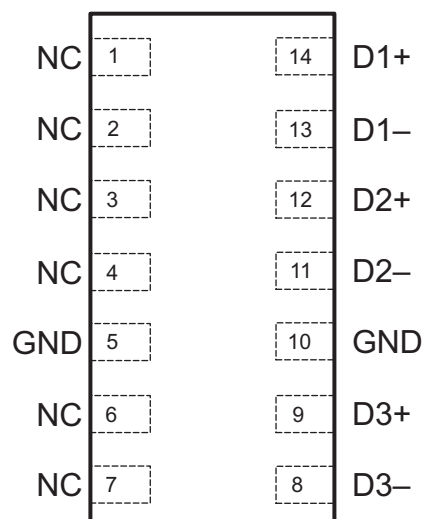
DQA

2.5 mm x 1 mm x 0.5 mm
(0.5-mm pitch)

RVZ

3.5 mm x 1.35 mm x 0.5 mm
(0.5-mm pitch)

DESCRIPTION

The TPDxE05U06 is a family of unidirectional ESD protection devices with ultra low capacitance. This family of devices is constructed with a central ESD clamp with two hiding diodes to reduce the capacitive loading. They are rated to dissipate ESD strikes above the maximum level specified in the IEC61000-4-2 level 4 international standard. Its ultra low loading capacitance makes it ideal for protecting any high-speed signal pins.



Please be aware that an important notice concerning availability, standard warranty, and use in critical applications of Texas Instruments semiconductor products and disclaimers thereto appears at the end of this data sheet.



This integrated circuit can be damaged by ESD. Texas Instruments recommends that all integrated circuits be handled with appropriate precautions. Failure to observe proper handling and installation procedures can cause damage.

ESD damage can range from subtle performance degradation to complete device failure. Precision integrated circuits may be more susceptible to damage because very small parametric changes could cause the device not to meet its published specifications.

FUNCTIONAL BLOCK DIAGRAM

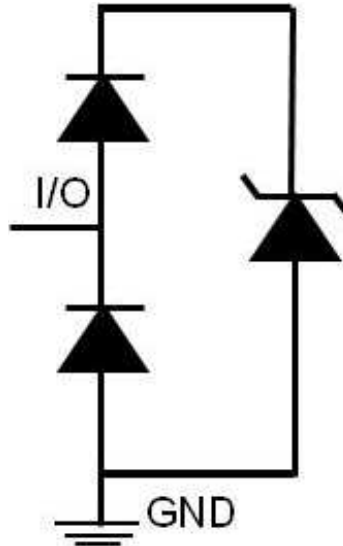

Figure 1. Single Channel Schematic Diagram

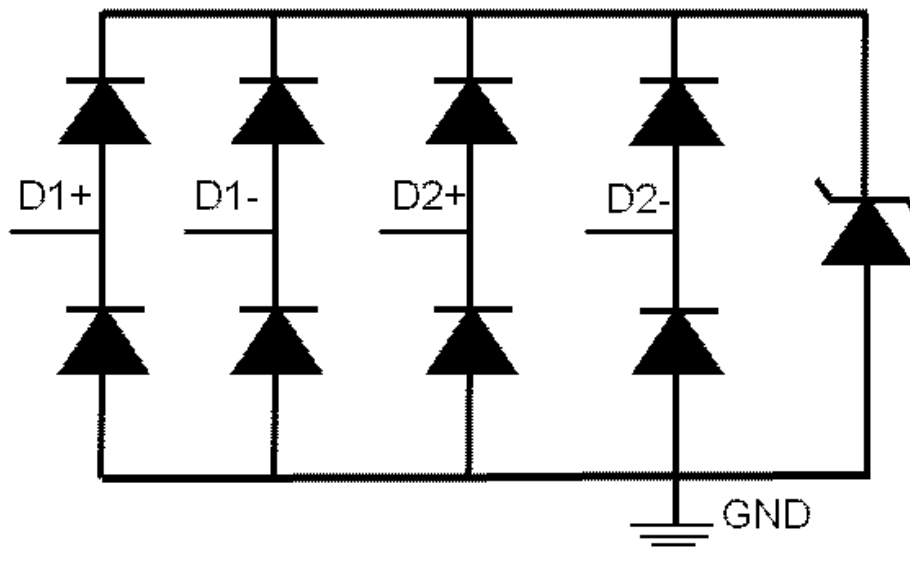

Figure 2. Quad Channel Schematic Diagram

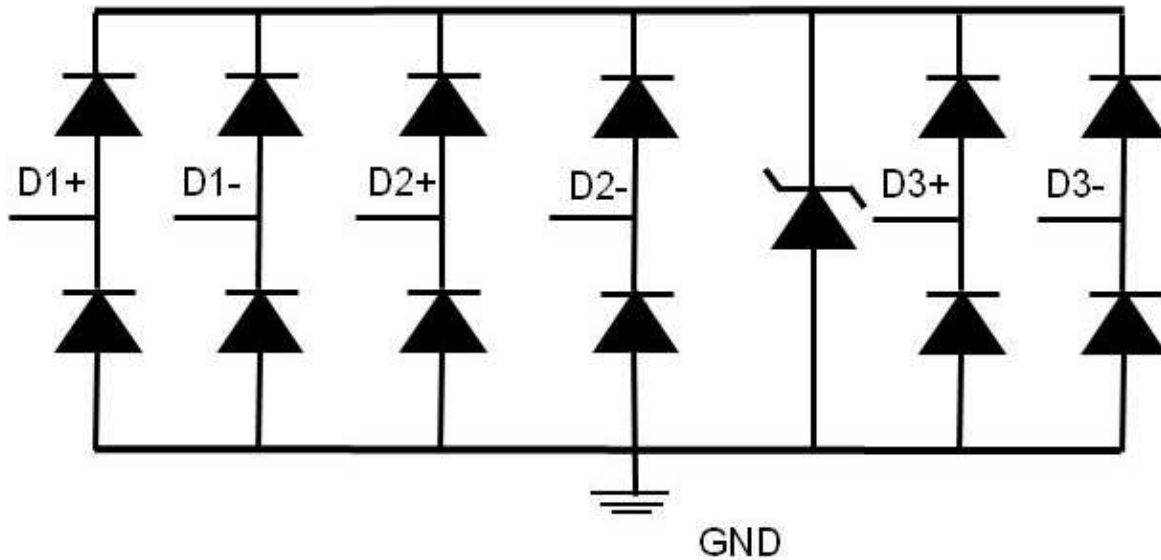

Figure 3. 6-Channel Schematic Diagram

SINGLE CHANNEL TERMINAL FUNCTIONS

TERMINAL		TYPE	DESCRIPTION	USAGE
NAME	PIN NO.			
I/O	1	I/O	ESD protected channel	Connect pin 1 as close to the connector as possible
GND	2	GND	Ground	Connect to ground

QUAD CHANNEL TERMINAL FUNCTIONS

TERMINAL		TYPE	DESCRIPTION	USAGE
NAME	PIN NO.			
D1+	1	I/O	ESD protected channel	Connect it as close to the connector as possible
D1–	2	I/O	ESD protected channel	Connect it as close to the connector as possible
D2+	4	I/O	ESD protected channel	Connect it as close to the connector as possible
D2–	5	I/O	ESD protected channel	Connect it as close to the connector as possible
NC	6, 7, 9, 10	NC	No connect	Used for optional straight-through routing from D+; otherwise can be left floating or grounded
GND	3, 8	GND	Ground	Connect to ground

SIX CHANNEL TERMINAL FUNCTIONS

TERMINAL		TYPE	DESCRIPTION	USAGE
NAME	PIN NO.			
D1+	14	I/O	ESD protected channel	Connect it as close to the connector as possible
D1–	13	I/O	ESD protected channel	Connect it as close to the connector as possible
D2+	12	I/O	ESD protected channel	Connect it as close to the connector as possible
D2–	11	I/O	ESD protected channel	Connect it as close to the connector as possible
D3+	9	I/O	ESD protected channel	Connect it as close to the connector as possible
D3–	8	I/O	ESD protected channel	Connect it as close to the connector as possible
NC	1, 2, 3, 4, 6, 7	NC	No connect	Used for optional straight-through routing from D+; otherwise can be left floating or grounded
GND	5, 10	GND	Ground	Connect to ground

ABSOLUTE MAXIMUM RATINGS⁽¹⁾

over operating free-air temperature range (unless otherwise noted)

PARAMETER		MIN	MAX	UNIT
T _A	Operating free-air temperature range	–40	125	°C
T _{stg}	Storage temperature range	–65	155	°C
ESD protection	IEC 61000-4-2 Contact Discharge ⁽²⁾		±12	kV
	IEC 61000-4-2 Air-Gap Discharge ⁽²⁾		±15	kV
I _{PP}	Peak pulse current (t _p = 8/20 μs) ⁽²⁾		2.5	A
P _{PP}	Peak pulse power (t _p = 8/20 μs) ⁽²⁾		40	W

(1) Stresses beyond those listed under "absolute maximum ratings" may cause permanent damage to the device. These are stress ratings only, and functional operation of the device at these or any other conditions beyond those indicated in the operational sections of the specifications is not implied. Exposure to absolute maximum-rated conditions for extended periods may affect device reliability.

(2) Measured at 25°C.

ELECTRICAL CHARACTERISTICS

over operating free-air temperature range (unless otherwise noted)

PARAMETER		TEST CONDITIONS	MIN	TYP	MAX	UNIT
V_{RWM}	Reverse stand-off voltage	$I_{IO} < 10 \mu A$			5.5	V
V_{clamp}	Clamp voltage	$I = 1A, TLP, I/O \text{ to ground}^{(1)}$		10		V
		$I = 5A, TLP, I/O \text{ to ground}^{(1)}$		14		
		$I = 1A, TLP, \text{ground to } I/O^{(1)}$		3		
		$I = 5A, TLP, \text{ground to } I/O^{(1)}$		7		
R_{DYN}	DPY package dynamic resistance	$I/O \text{ to GND}^{(2)}$		0.65		Ω
		$GND \text{ to } I/O^{(2)}$		0.8		
	DQA package dynamic resistance	$I/O \text{ to GND}^{(2)}$		0.8		Ω
		$GND \text{ to } I/O^{(2)}$		0.8		
	RVZ package dynamic resistance	$I/O \text{ to GND}^{(2)}$		0.8		Ω
		$GND \text{ to } I/O^{(2)}$		0.8		
C_L	Line capacitance ⁽³⁾	$V_{IO} = 2.5 V, F = 1 MHz,$ $I/O \text{ to GND}$	DPY package	0.42		pF
			DQA package	0.5		
			RVZ package	0.47		
C_{CROSS}	Channel to channel input capacitance	$GND \text{ Pin} = 0 V, F = 1 GHz, V_{BIAS} = 2.5 V,$ $\text{between channel pins}$		0.01	0.06	pF
$\Delta C_{IO-TO-GND}$	Variation of channel input capacitance	$GND \text{ Pin} = 0 V, F = 1 GHz, V_{BIAS} = 2.5 V,$ $\text{channel}_x \text{ pin to gnd} - \text{channel}_y \text{ pin to gnd}$		0.05	0.07	pF
V_{BR}	Break-down voltage	$I_{IO} = 1 mA$	6.5		8.5	V
I_{LEAK}	Leakage current	$V_{IO} = 2.5 V$		1	10	nA

(1) Transition line pulse with 100ns width, 200ps rise time.

 (2) Extraction of RDYIN using least squares fit of TLP characteristics between $I = 10 A$ and $I = 20 A$.

(3) Capacitance data is taken at 25°C.

TYPICAL CHARACTERISTICS

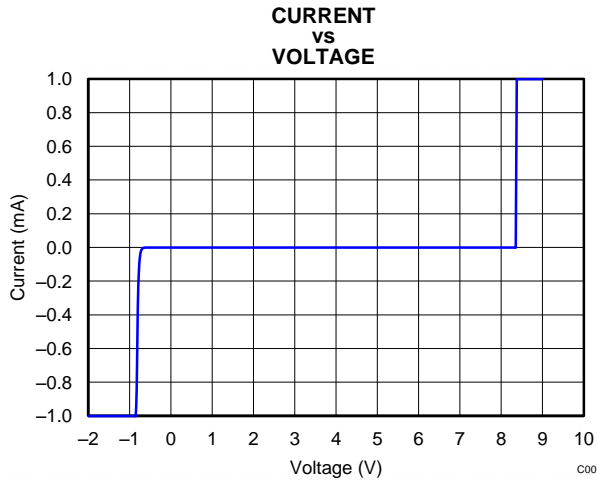

Figure 4. DC Voltage Sweep I-V Curve

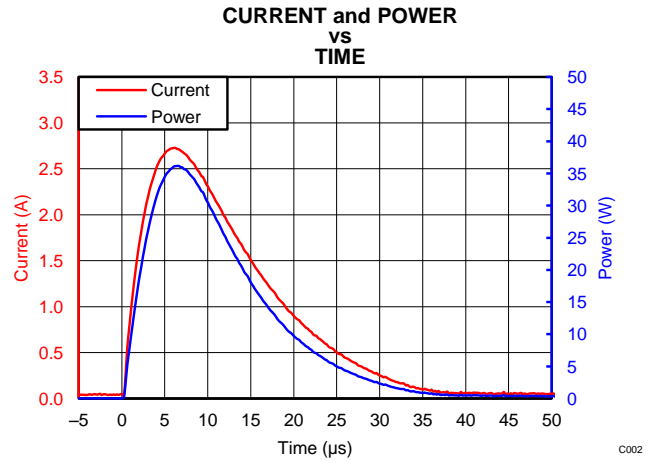

Figure 5. Surge Curve ($t_p = 8/20\mu s$), Pin IO to GND

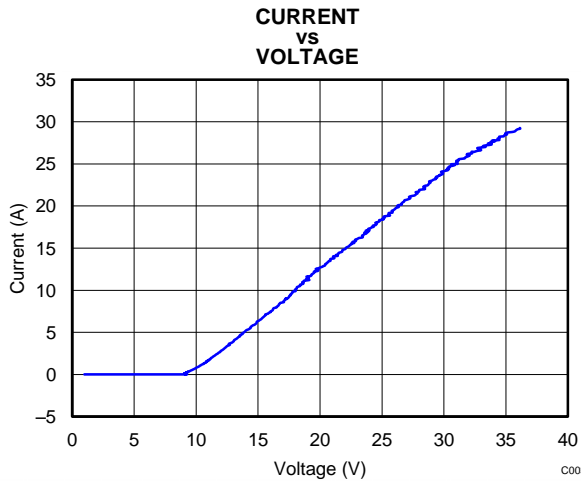

Figure 6. Positive TLP Plot IO to GND

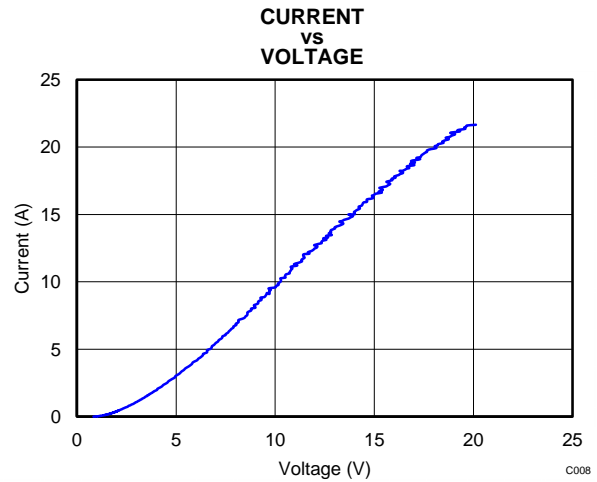

Figure 7. Negative TLP Plot IO to GND

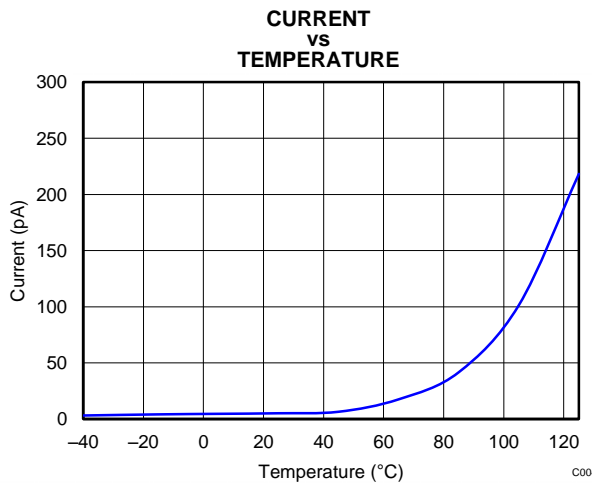

Figure 8. Leakage vs Temp

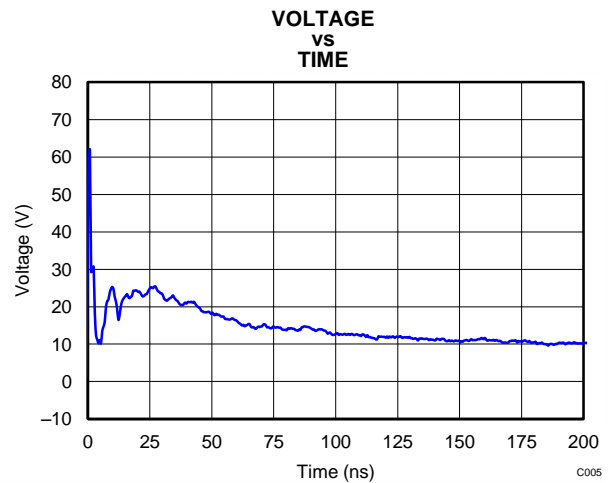

Figure 9. +8kV IEC Waveform

TYPICAL CHARACTERISTICS (continued)

VOLTAGE
VS
TIME

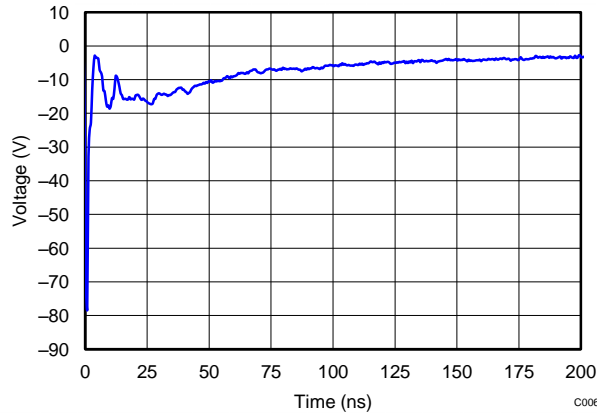

Figure 10. -8kV IEC Waveform

INSERTION LOSS
VS
FREQUENCY

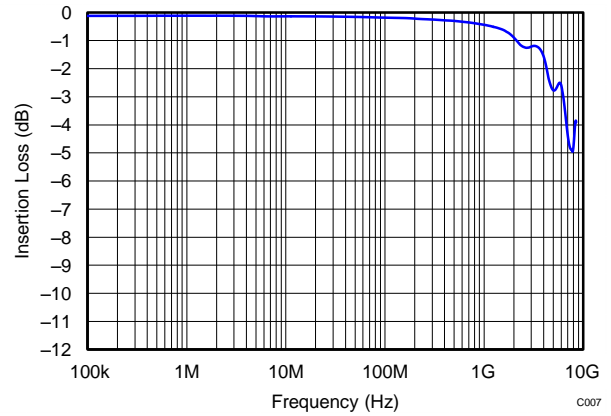

Figure 11. TPD1E05U06 Insertion Loss

INSERTION LOSS
VS
FREQUENCY

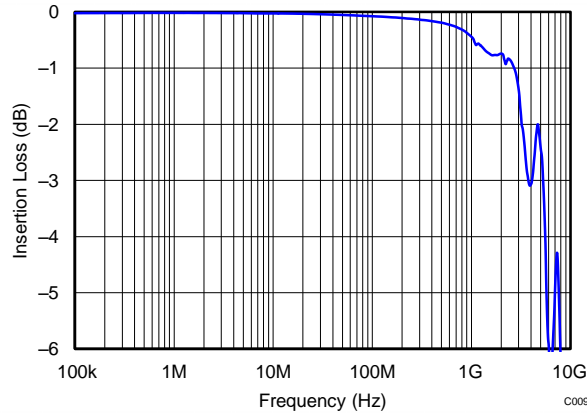

Figure 12. TPD4E05U06 Insertion Loss

INSERTION LOSS
VS
FREQUENCY

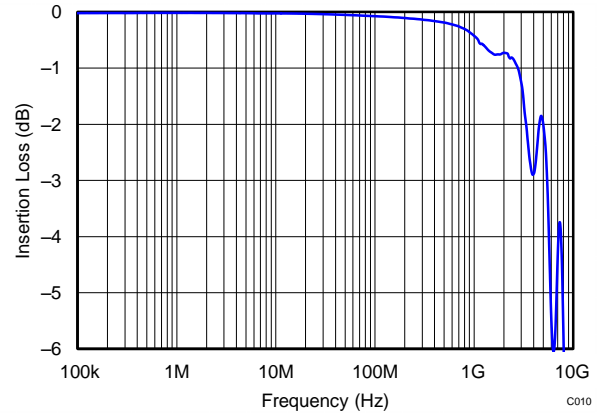
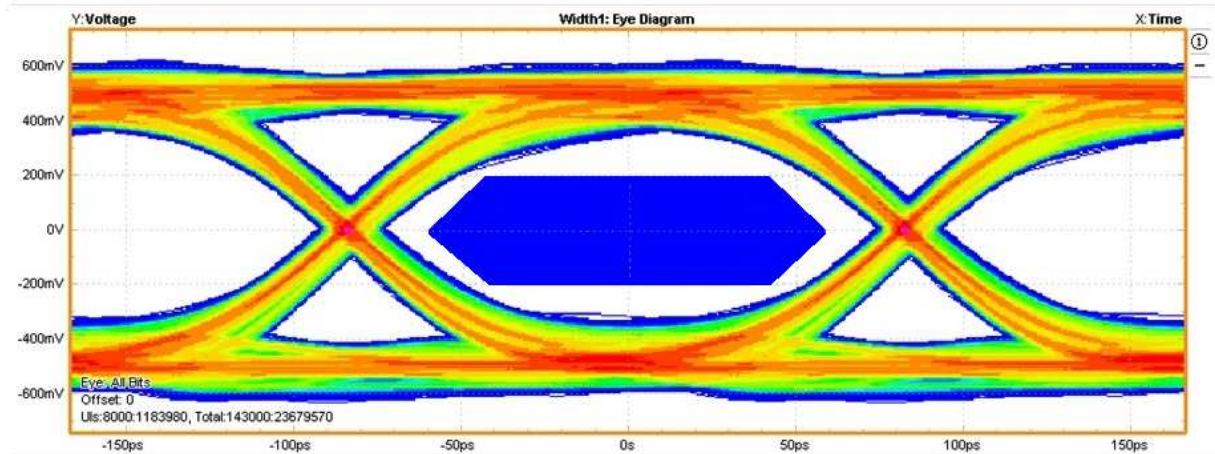

Figure 13. TPD6E05U06 Insertion Loss

TYPICAL CHARACTERISTICS (continued)

6 Gbps HDMI Eye Diagram



3.4 Gbps HDMI Eye Diagram

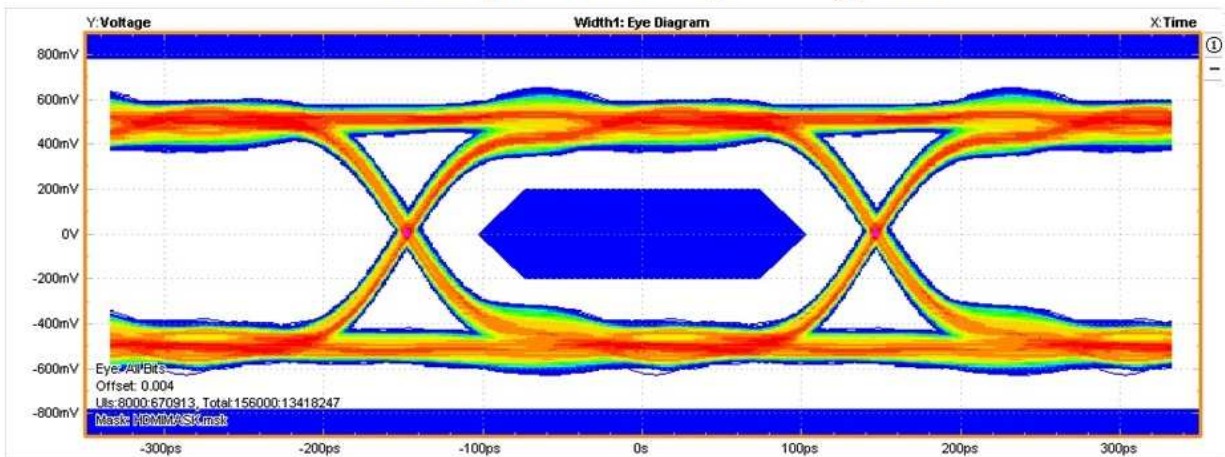

Figure 14. TPD1E05U06 Eye Diagrams

TYPICAL CHARACTERISTICS (continued)

3.4 Gbps HDMI Eye Diagram

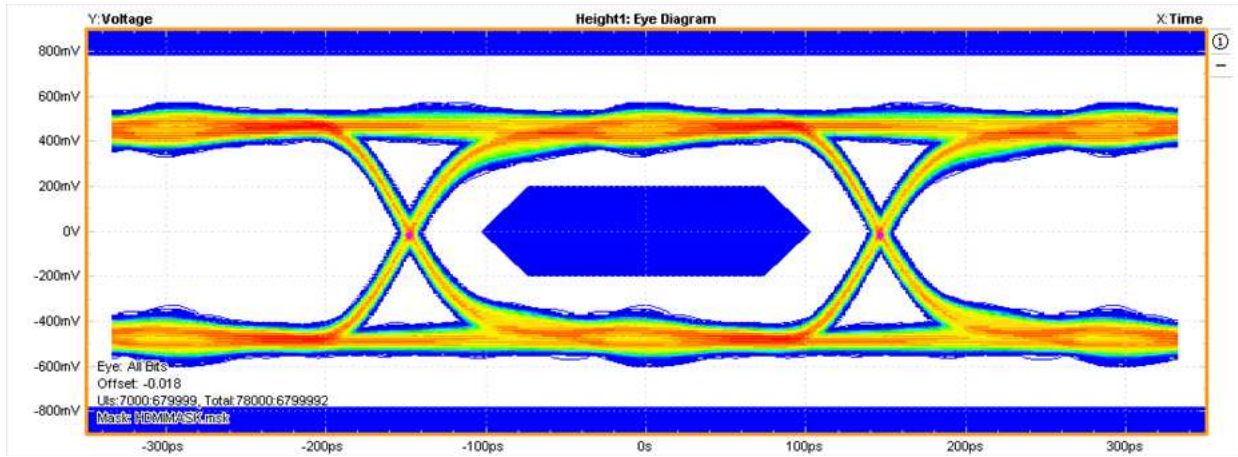

Figure 15. TPD4E05U06 Eye Diagram

3.4 Gbps HDMI Eye Diagram

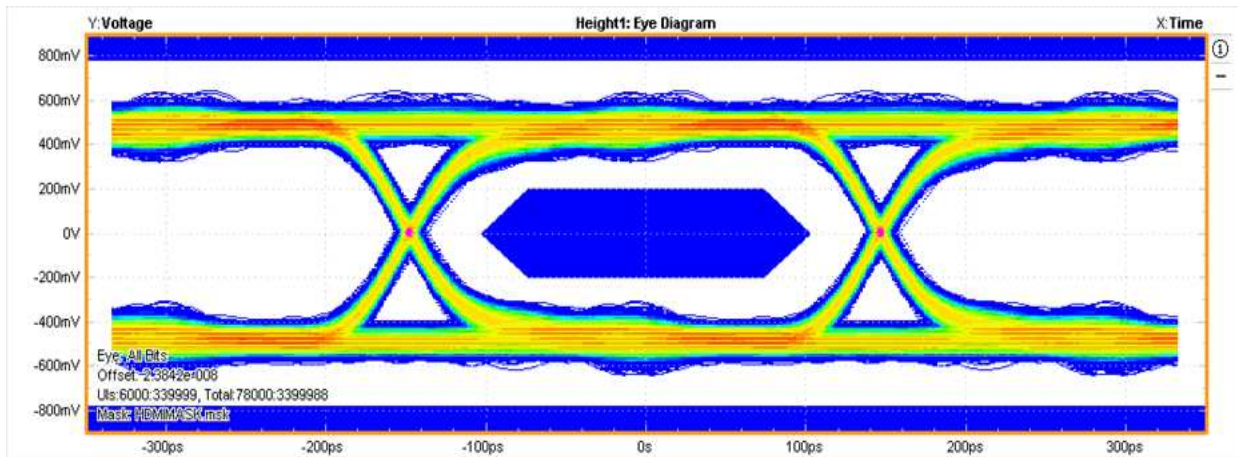

Figure 16. TPD6E05U06 Eye Diagram

REVISION HISTORY

Changes from Original (December 2012) to Revision A	Page																		
• Added TPS2EUSB30A part to document.	1																		
<table style="width: 100%; border-collapse: collapse;"> <thead> <tr> <th style="text-align: left; border-bottom: 1px solid black;">Changes from Revision A (December 2012) to Revision B</th> <th style="text-align: right; border-bottom: 1px solid black;">Page</th> </tr> </thead> <tbody> <tr> <td style="border-top: 1px solid black;">• Added Insertion Loss Graphic.</td> <td style="text-align: right; border-top: 1px solid black;">6</td> </tr> <tr> <td style="border-top: 1px solid black;">• Added Eye Diagrams.</td> <td style="text-align: right; border-top: 1px solid black;">8</td> </tr> </tbody> </table>		Changes from Revision A (December 2012) to Revision B	Page	• Added Insertion Loss Graphic.	6	• Added Eye Diagrams.	8												
Changes from Revision A (December 2012) to Revision B	Page																		
• Added Insertion Loss Graphic.	6																		
• Added Eye Diagrams.	8																		
<table style="width: 100%; border-collapse: collapse;"> <thead> <tr> <th style="text-align: left; border-bottom: 1px solid black;">Changes from Revision B (January 2013) to Revision C</th> <th style="text-align: right; border-bottom: 1px solid black;">Page</th> </tr> </thead> <tbody> <tr> <td style="border-top: 1px solid black;">• Changed IO Capacitance range</td> <td style="text-align: right; border-top: 1px solid black;">1</td> </tr> <tr> <td style="border-top: 1px solid black;">• Changed test conditions and typ values for V_{clamp}</td> <td style="text-align: right; border-top: 1px solid black;">5</td> </tr> <tr> <td style="border-top: 1px solid black;">• Added typ R_{DYN} values for DQA and RVZ packages</td> <td style="text-align: right; border-top: 1px solid black;">5</td> </tr> <tr> <td style="border-top: 1px solid black;">• Added C_L values for DQA and RVZ packages</td> <td style="text-align: right; border-top: 1px solid black;">5</td> </tr> <tr> <td style="border-top: 1px solid black;">• Changed table note (1)</td> <td style="text-align: right; border-top: 1px solid black;">5</td> </tr> <tr> <td style="border-top: 1px solid black;">• Changed CURRENT vs VOLTAGE graphic</td> <td style="text-align: right; border-top: 1px solid black;">6</td> </tr> <tr> <td style="border-top: 1px solid black;">• Changed Insertion Loss graphic</td> <td style="text-align: right; border-top: 1px solid black;">6</td> </tr> <tr> <td style="border-top: 1px solid black;">• Changed HDMI Eye Diagrams</td> <td style="text-align: right; border-top: 1px solid black;">8</td> </tr> </tbody> </table>		Changes from Revision B (January 2013) to Revision C	Page	• Changed IO Capacitance range	1	• Changed test conditions and typ values for V_{clamp}	5	• Added typ R_{DYN} values for DQA and RVZ packages	5	• Added C_L values for DQA and RVZ packages	5	• Changed table note (1)	5	• Changed CURRENT vs VOLTAGE graphic	6	• Changed Insertion Loss graphic	6	• Changed HDMI Eye Diagrams	8
Changes from Revision B (January 2013) to Revision C	Page																		
• Changed IO Capacitance range	1																		
• Changed test conditions and typ values for V_{clamp}	5																		
• Added typ R_{DYN} values for DQA and RVZ packages	5																		
• Added C_L values for DQA and RVZ packages	5																		
• Changed table note (1)	5																		
• Changed CURRENT vs VOLTAGE graphic	6																		
• Changed Insertion Loss graphic	6																		
• Changed HDMI Eye Diagrams	8																		
<table style="width: 100%; border-collapse: collapse;"> <thead> <tr> <th style="text-align: left; border-bottom: 1px solid black;">Changes from Revision C (March 2013) to Revision D</th> <th style="text-align: right; border-bottom: 1px solid black;">Page</th> </tr> </thead> <tbody> <tr> <td style="border-top: 1px solid black;">• Updated Title.</td> <td style="text-align: right; border-top: 1px solid black;">1</td> </tr> <tr> <td style="border-top: 1px solid black;">• Removed Ordering Information table.</td> <td style="text-align: right; border-top: 1px solid black;">2</td> </tr> </tbody> </table>		Changes from Revision C (March 2013) to Revision D	Page	• Updated Title.	1	• Removed Ordering Information table.	2												
Changes from Revision C (March 2013) to Revision D	Page																		
• Updated Title.	1																		
• Removed Ordering Information table.	2																		

PACKAGING INFORMATION

Orderable Device	Status (1)	Package Type	Package Drawing	Pins	Package Qty	Eco Plan (2)	Lead/Ball Finish	MSL Peak Temp (3)	Op Temp (°C)	Device Marking (4/5)	Samples
TPD1E05U06DPYR	ACTIVE	X2SON	DPY	2	10000	Green (RoHS & no Sb/Br)	CU NIPDAU	Level-1-260C-UNLIM	-40 to 85	C1	Samples
TPD1E05U06DPYT	ACTIVE	X2SON	DPY	2	250	Green (RoHS & no Sb/Br)	CU NIPDAU	Level-1-260C-UNLIM	-40 to 85	C1	Samples
TPD4E05U06DQAR	ACTIVE	SON	DQA	10	3000	Green (RoHS & no Sb/Br)	CU NIPDAU	Level-1-260C-UNLIM	-40 to 85	BRL	Samples
TPD6E05U06RVZR	ACTIVE	UQFN	RVZ	14	3000	Green (RoHS & no Sb/Br)	CU NIPDAU	Level-1-260C-UNLIM	-40 to 85	BVL	Samples

(1) The marketing status values are defined as follows:

ACTIVE: Product device recommended for new designs.

LIFEBUY: TI has announced that the device will be discontinued, and a lifetime-buy period is in effect.

NRND: Not recommended for new designs. Device is in production to support existing customers, but TI does not recommend using this part in a new design.

PREVIEW: Device has been announced but is not in production. Samples may or may not be available.

OBSELETE: TI has discontinued the production of the device.

(2) Eco Plan - The planned eco-friendly classification: Pb-Free (RoHS), Pb-Free (RoHS Exempt), or Green (RoHS & no Sb/Br) - please check <http://www.ti.com/productcontent> for the latest availability information and additional product content details.

TBD: The Pb-Free/Green conversion plan has not been defined.

Pb-Free (RoHS): TI's terms "Lead-Free" or "Pb-Free" mean semiconductor products that are compatible with the current RoHS requirements for all 6 substances, including the requirement that lead not exceed 0.1% by weight in homogeneous materials. Where designed to be soldered at high temperatures, TI Pb-Free products are suitable for use in specified lead-free processes.

Pb-Free (RoHS Exempt): This component has a RoHS exemption for either 1) lead-based flip-chip solder bumps used between the die and package, or 2) lead-based die adhesive used between the die and leadframe. The component is otherwise considered Pb-Free (RoHS compatible) as defined above.

Green (RoHS & no Sb/Br): TI defines "Green" to mean Pb-Free (RoHS compatible), and free of Bromine (Br) and Antimony (Sb) based flame retardants (Br or Sb do not exceed 0.1% by weight in homogeneous material)

(3) MSL, Peak Temp. -- The Moisture Sensitivity Level rating according to the JEDEC industry standard classifications, and peak solder temperature.

(4) There may be additional marking, which relates to the logo, the lot trace code information, or the environmental category on the device.

(5) Multiple Device Markings will be inside parentheses. Only one Device Marking contained in parentheses and separated by a "~" will appear on a device. If a line is indented then it is a continuation of the previous line and the two combined represent the entire Device Marking for that device.

Important Information and Disclaimer: The information provided on this page represents TI's knowledge and belief as of the date that it is provided. TI bases its knowledge and belief on information provided by third parties, and makes no representation or warranty as to the accuracy of such information. Efforts are underway to better integrate information from third parties. TI has taken and

continues to take reasonable steps to provide representative and accurate information but may not have conducted destructive testing or chemical analysis on incoming materials and chemicals. TI and TI suppliers consider certain information to be proprietary, and thus CAS numbers and other limited information may not be available for release.

In no event shall TI's liability arising out of such information exceed the total purchase price of the TI part(s) at issue in this document sold by TI to Customer on an annual basis.

TAPE AND REEL INFORMATION



QUADRANT ASSIGNMENTS FOR PIN 1 ORIENTATION IN TAPE



*All dimensions are nominal

Device	Package Type	Package Drawing	Pins	SPQ	Reel Diameter (mm)	Reel Width W1 (mm)	A0 (mm)	B0 (mm)	K0 (mm)	P1 (mm)	W (mm)	Pin1 Quadrant
TPD1E05U06DPYR	X2SON	DPY	2	10000	180.0	9.5	0.66	1.15	0.66	4.0	8.0	Q1
TPD1E05U06DPYT	X2SON	DPY	2	250	180.0	9.5	0.66	1.15	0.66	4.0	8.0	Q1
TPD4E05U06DQAR	SON	DQA	10	3000	180.0	9.5	1.23	2.7	0.7	4.0	8.0	Q1
TPD6E05U06RVZR	UQFN	RVZ	14	3000	330.0	12.4	1.65	3.8	0.7	4.0	12.0	Q1

TAPE AND REEL BOX DIMENSIONS

*All dimensions are nominal

Device	Package Type	Package Drawing	Pins	SPQ	Length (mm)	Width (mm)	Height (mm)
TPD1E05U06DPYR	X2SON	DPY	2	10000	180.0	180.0	30.0
TPD1E05U06DPYT	X2SON	DPY	2	250	180.0	180.0	30.0
TPD4E05U06DQAR	SON	DQA	10	3000	180.0	180.0	30.0
TPD6E05U06RVZR	UQFN	RVZ	14	3000	180.0	180.0	30.0

DQA (R-PSON-N10)

PLASTIC SMALL OUTLINE NO-LEAD

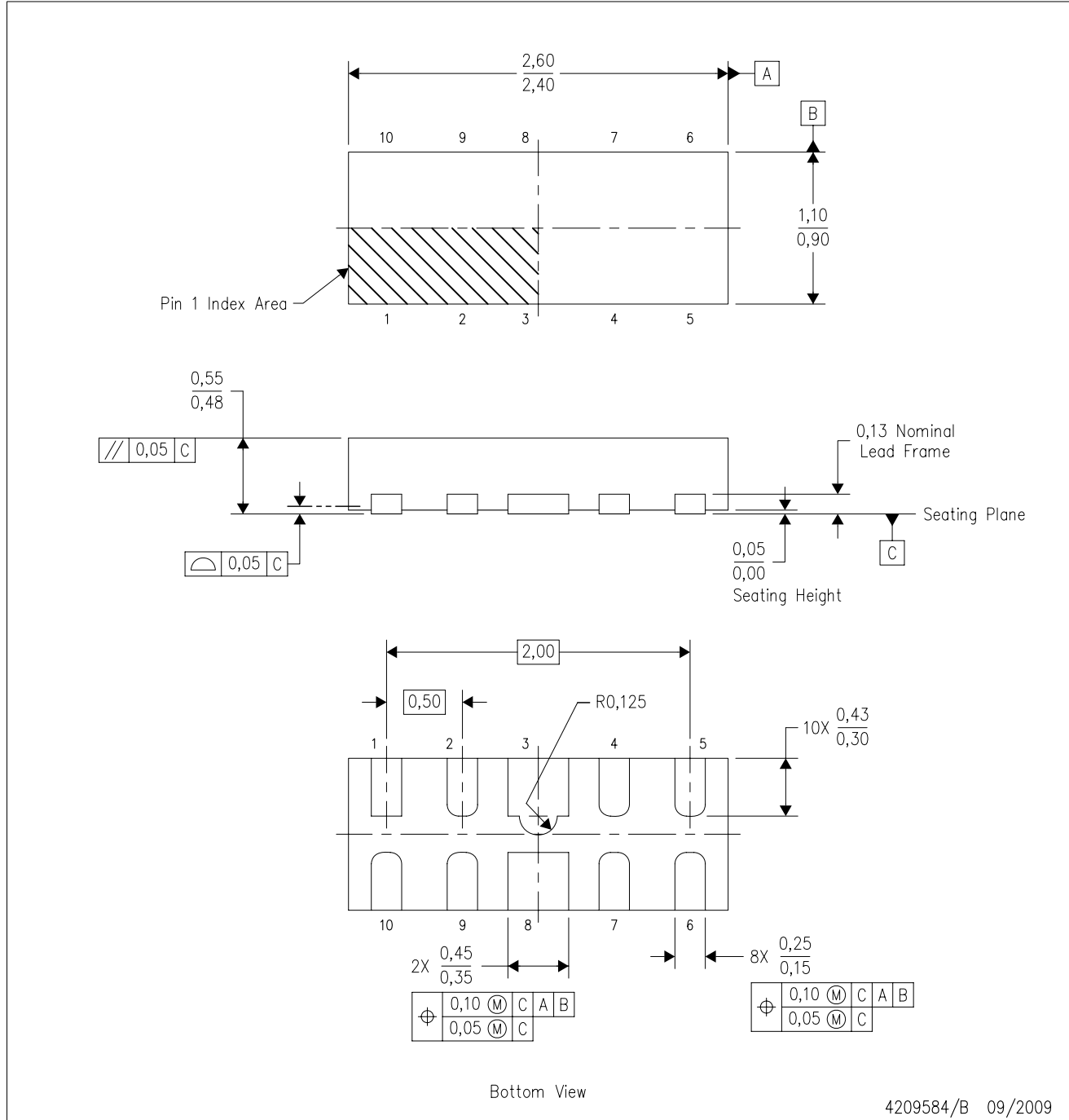

4209584/B 09/2009

- NOTES:
- A. All linear dimensions are in millimeters. Dimensioning and tolerancing per ASME Y14.5M-1994.
 - B. This drawing is subject to change without notice.
 - C. SON (Small Outline No-Lead) package configuration.

DQA (R-PUSON-N10)

PLASTIC SMALL OUTLINE NO-LEAD

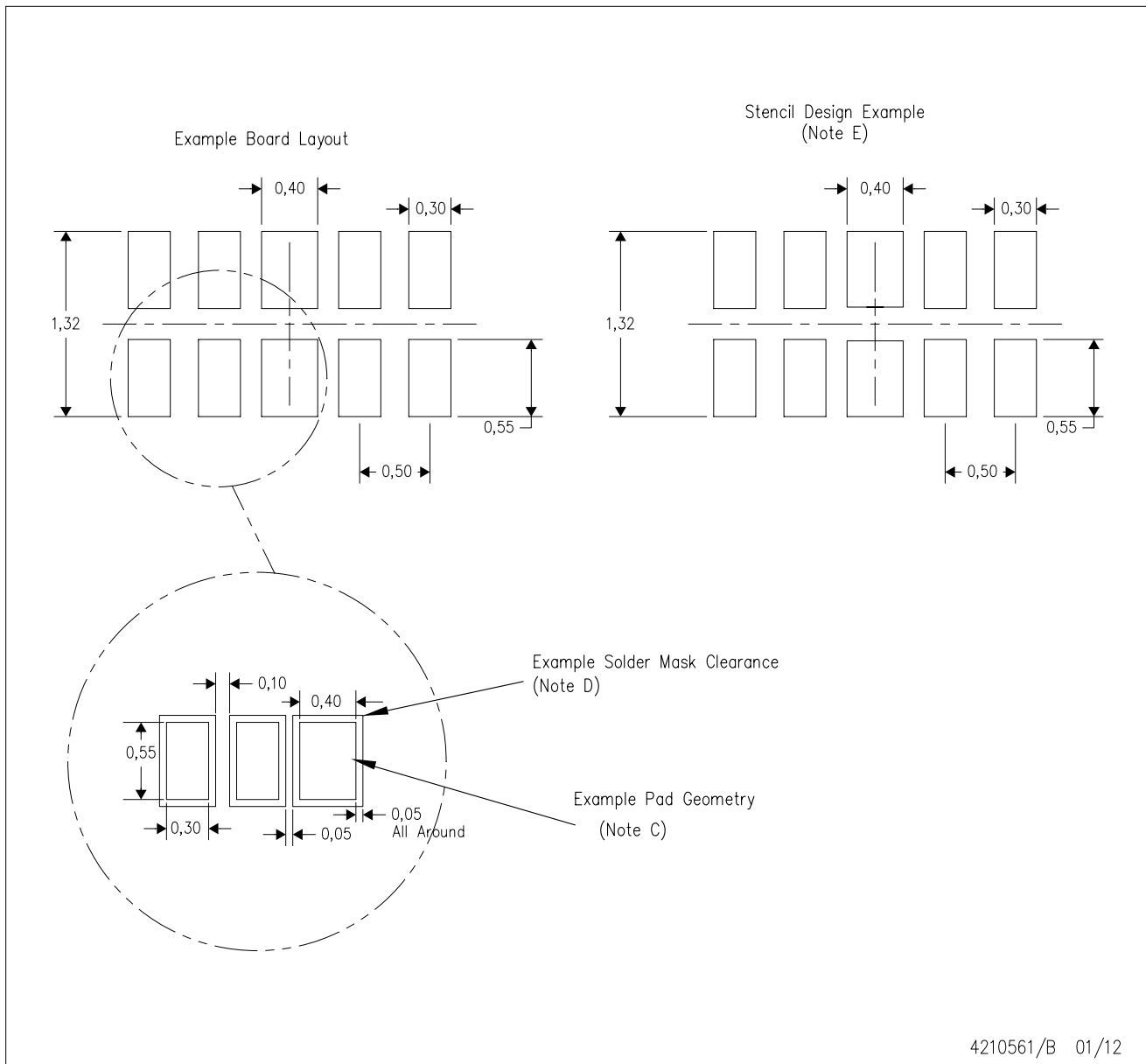

- NOTES:
- All linear dimensions are in millimeters.
 - This drawing is subject to change without notice.
 - Publication IPC-7351 is recommended for alternate designs.
 - Customers should contact their board fabrication site for minimum solder mask web tolerances between signal pads.
 - Maximum stencil thickness 0,127 mm (5 mils). All linear dimensions are in millimeters.
 - Laser cutting apertures with trapezoidal walls and also rounding corners will offer better paste release. Customers should contact their board assembly site for stencil design recommendations. Refer to IPC 7525 for stencil design considerations.
 - Side aperture dimensions over-print land for acceptable area ratio > 0.66. Customer may reduce side aperture dimensions if stencil manufacturing process allows for sufficient release at smaller opening.

DPY (R-PX2SON-N2)

PLASTIC SMALL OUTLINE NO-LEAD

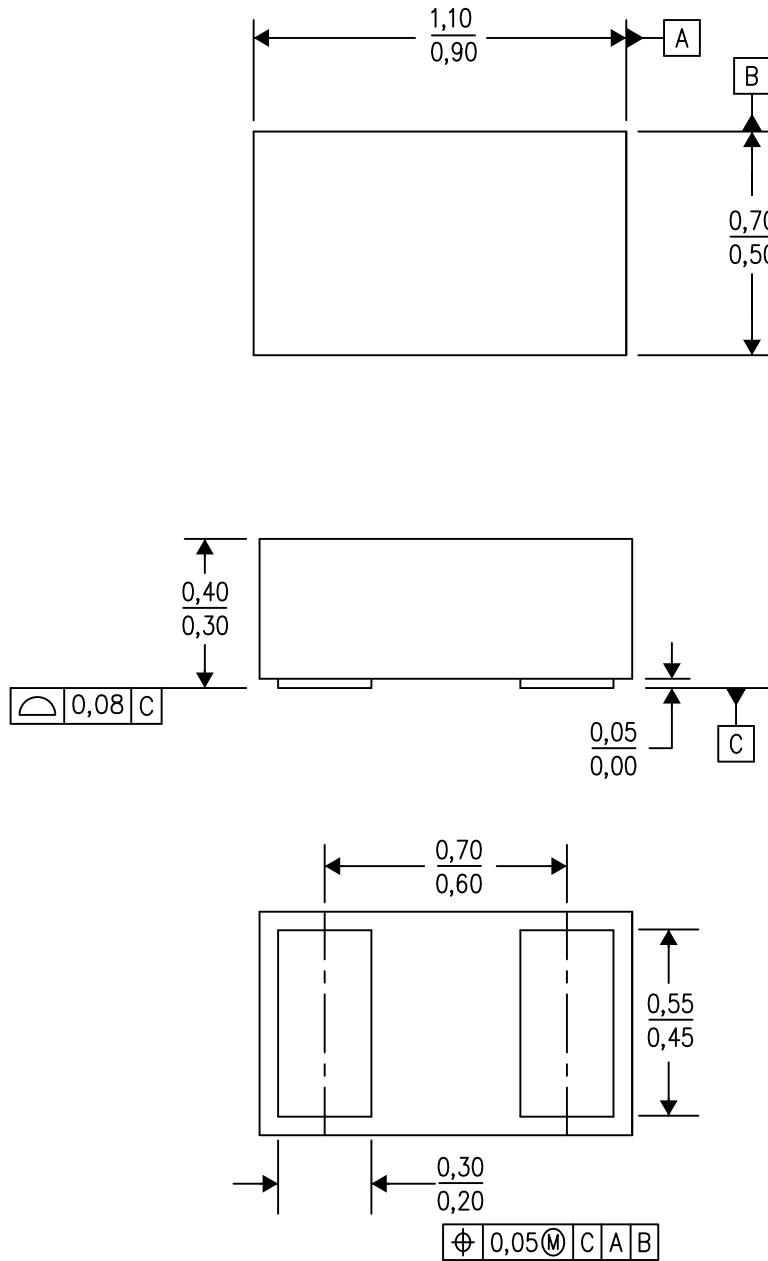

4211012/B 08/12

- NOTES:
- All linear dimensions are in millimeters. Dimensioning and tolerancing per ASME Y14.5-1994.
 - This drawing is subject to change without notice.
 - SON (Small Outline No-Lead) package configuration.

DPY (S-PX2SON-N2)

PLASTIC SMALL OUTLINE NO-LEAD

Example Board Layout

Example Stencil Design
(Note E)

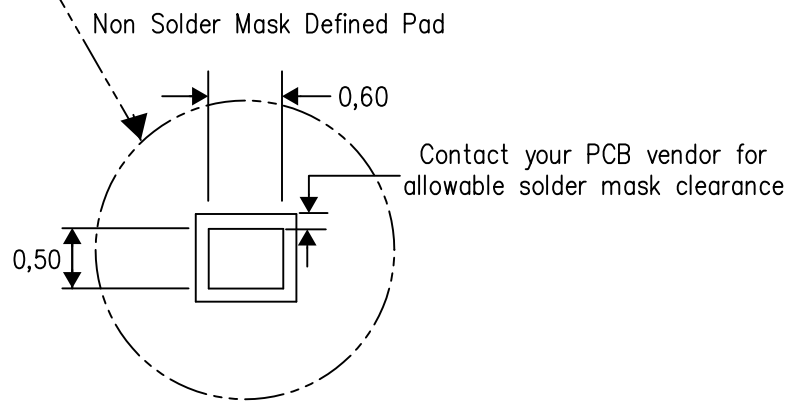
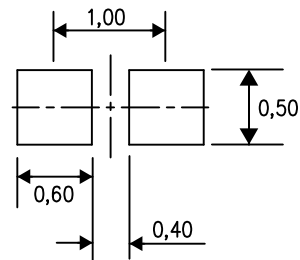
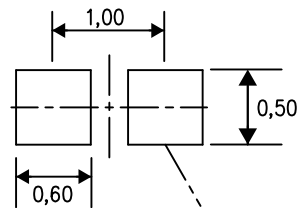

4215270/A 08/12

- NOTES:
- A. All linear dimensions are in millimeters.
 - B. This drawing is subject to change without notice.
 - C. Publication IPC-7351 is recommended for alternate designs.
 - D. Customers should contact their board fabrication site for minimum solder mask web tolerances between signal pads.
 - E. Maximum stencil thickness 0,127 mm (5 mils). All linear dimensions are in millimeters.
 - F. Laser cutting apertures with trapezoidal walls and also rounding corners will offer better paste release. Customers should contact their board assembly site for stencil design recommendations. Refer to IPC 7525 for stencil design considerations.
 - G. Side aperture dimensions over-print land for acceptable area ratio > 0.66. Customer may reduce side aperture dimensions if stencil manufacturing process allows for sufficient release at smaller opening.

IMPORTANT NOTICE

Texas Instruments Incorporated and its subsidiaries (TI) reserve the right to make corrections, enhancements, improvements and other changes to its semiconductor products and services per JESD46, latest issue, and to discontinue any product or service per JESD48, latest issue. Buyers should obtain the latest relevant information before placing orders and should verify that such information is current and complete. All semiconductor products (also referred to herein as "components") are sold subject to TI's terms and conditions of sale supplied at the time of order acknowledgment.

TI warrants performance of its components to the specifications applicable at the time of sale, in accordance with the warranty in TI's terms and conditions of sale of semiconductor products. Testing and other quality control techniques are used to the extent TI deems necessary to support this warranty. Except where mandated by applicable law, testing of all parameters of each component is not necessarily performed.

TI assumes no liability for applications assistance or the design of Buyers' products. Buyers are responsible for their products and applications using TI components. To minimize the risks associated with Buyers' products and applications, Buyers should provide adequate design and operating safeguards.

TI does not warrant or represent that any license, either express or implied, is granted under any patent right, copyright, mask work right, or other intellectual property right relating to any combination, machine, or process in which TI components or services are used. Information published by TI regarding third-party products or services does not constitute a license to use such products or services or a warranty or endorsement thereof. Use of such information may require a license from a third party under the patents or other intellectual property of the third party, or a license from TI under the patents or other intellectual property of TI.

Reproduction of significant portions of TI information in TI data books or data sheets is permissible only if reproduction is without alteration and is accompanied by all associated warranties, conditions, limitations, and notices. TI is not responsible or liable for such altered documentation. Information of third parties may be subject to additional restrictions.

Resale of TI components or services with statements different from or beyond the parameters stated by TI for that component or service voids all express and any implied warranties for the associated TI component or service and is an unfair and deceptive business practice. TI is not responsible or liable for any such statements.

Buyer acknowledges and agrees that it is solely responsible for compliance with all legal, regulatory and safety-related requirements concerning its products, and any use of TI components in its applications, notwithstanding any applications-related information or support that may be provided by TI. Buyer represents and agrees that it has all the necessary expertise to create and implement safeguards which anticipate dangerous consequences of failures, monitor failures and their consequences, lessen the likelihood of failures that might cause harm and take appropriate remedial actions. Buyer will fully indemnify TI and its representatives against any damages arising out of the use of any TI components in safety-critical applications.

In some cases, TI components may be promoted specifically to facilitate safety-related applications. With such components, TI's goal is to help enable customers to design and create their own end-product solutions that meet applicable functional safety standards and requirements. Nonetheless, such components are subject to these terms.

No TI components are authorized for use in FDA Class III (or similar life-critical medical equipment) unless authorized officers of the parties have executed a special agreement specifically governing such use.

Only those TI components which TI has specifically designated as military grade or "enhanced plastic" are designed and intended for use in military/aerospace applications or environments. Buyer acknowledges and agrees that any military or aerospace use of TI components which have **not** been so designated is solely at the Buyer's risk, and that Buyer is solely responsible for compliance with all legal and regulatory requirements in connection with such use.

TI has specifically designated certain components as meeting ISO/TS16949 requirements, mainly for automotive use. In any case of use of non-designated products, TI will not be responsible for any failure to meet ISO/TS16949.

Products

Audio	www.ti.com/audio
Amplifiers	amplifier.ti.com
Data Converters	dataconverter.ti.com
DLP® Products	www.dlp.com
DSP	dsp.ti.com
Clocks and Timers	www.ti.com/clocks
Interface	interface.ti.com
Logic	logic.ti.com
Power Mgmt	power.ti.com
Microcontrollers	microcontroller.ti.com
RFID	www.ti-rfid.com
OMAP Applications Processors	www.ti.com/omap
Wireless Connectivity	www.ti.com/wirelessconnectivity

Applications

Automotive and Transportation	www.ti.com/automotive
Communications and Telecom	www.ti.com/communications
Computers and Peripherals	www.ti.com/computers
Consumer Electronics	www.ti.com/consumer-apps
Energy and Lighting	www.ti.com/energy
Industrial	www.ti.com/industrial
Medical	www.ti.com/medical
Security	www.ti.com/security
Space, Avionics and Defense	www.ti.com/space-avionics-defense
Video and Imaging	www.ti.com/video

TI E2E Community

e2e.ti.com