

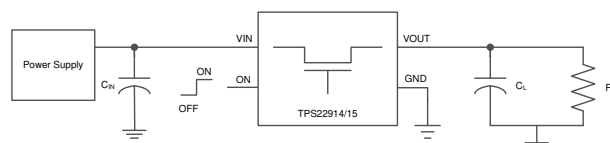
## TPS2291xx, 5.5-V, 2-A, 37-mΩ On-Resistance Load Switch

### 1 Features

- Integrated Single Channel Load Switch
- Input Voltage Range: 1.05 V to 5.5 V
- Low On-Resistance ( $R_{ON}$ )
  - $R_{ON} = 37\text{ m}\Omega$  (Typical) at  $V_{IN} = 5\text{ V}$
  - $R_{ON} = 38\text{ m}\Omega$  (Typical) at  $V_{IN} = 3.3\text{ V}$
  - $R_{ON} = 43\text{ m}\Omega$  (Typical) at  $V_{IN} = 1.8\text{ V}$
- 2-A Maximum Continuous Switch Current
- Low Quiescent Current
  - $7.7\text{ }\mu\text{A}$  (Typical) at  $V_{IN} = 3.3\text{ V}$
- Low Control Input Threshold Enables Use of 1 V or Higher GPIO
- Controlled Slew Rate
  - $t_R(\text{TPS22914B/15B}) = 64\text{ }\mu\text{s}$  at  $V_{IN} = 3.3\text{ V}$
  - $t_R(\text{TPS22914C/15C}) = 913\text{ }\mu\text{s}$  at  $V_{IN} = 3.3\text{ V}$
- Quick Output Discharge (TPS22915 only)
- Ultra-Small Wafer-Chip-Scale Package
  - $0.78\text{ mm} \times 0.78\text{ mm}$ , 0.4-mm Pitch, 0.5-mm Height (YFP)
- ESD Performance Tested per JESD 22
  - 2-kV HBM and 1-kV CDM

### 2 Applications

- Smartphones, Mobile Phones
- Ultrathin, Ultrabook™ / Notebook PC
- Tablet PC, Phablet
- Wearable Technology
- Solid State Drives
- Digital Cameras



**Simplified Schematic**

### 3 Description

The TPS22914/15 is a small, low  $R_{ON}$ , single channel load switch with controlled slew rate. The device contains an N-channel MOSFET that can operate over an input voltage range of 1.05 V to 5.5 V and can support a maximum continuous current of 2 A. The switch is controlled by an on and off input, which is capable of interfacing directly with low-voltage control signals.

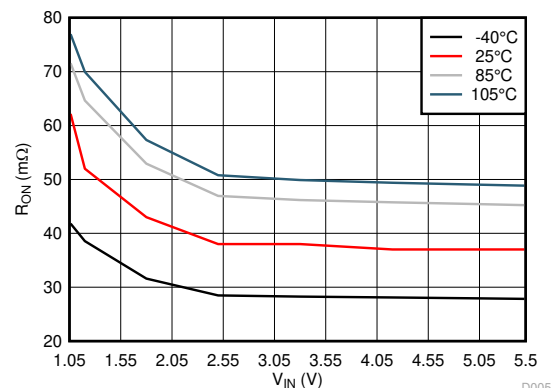
The small size and low  $R_{ON}$  makes the device ideal for being used in space constrained, battery powered applications. The wide input voltage range of the switch makes it a versatile solution for many different voltage rails. The controlled rise time of the device greatly reduces inrush current caused by large bulk load capacitances, thereby reducing or eliminating power supply droop. The TPS22915 further reduces the total solution size by integrating a 143- $\Omega$  pull-down resistor for quick output discharge (QOD) when the switch is turned off.

The TPS22914/15 is available in a small, space-saving  $0.78\text{ mm} \times 0.78\text{ mm}$ , 0.4-mm pitch, 0.5-mm height 4-pin Wafer-Chip-Scale (WCSP) package (YFP). The device is characterized for operation over the free-air temperature range of  $-40^\circ\text{C}$  to  $+105^\circ\text{C}$ .

#### Device Information (1)

PART NUMBER	PACKAGE	BODY SIZE (NOM)
TPS22914B	DSBGA (4)	0.74 mm x 0.74 mm
TPS22914C		
TPS22915B		
TPS22915C		

- (1) For all available packages, see the orderable addendum at the end of the datasheet.



**$R_{ON}$  vs  $V_{IN}$  ( $I_{OUT} = -200\text{ mA}$ )**



## Table of Contents

<b>1 Features</b> .....	1	9.3 Feature Description.....	17
<b>2 Applications</b> .....	1	9.4 Device Functional Modes.....	18
<b>3 Description</b> .....	1	<b>10 Application and Implementation</b> .....	19
<b>4 Revision History</b> .....	2	10.1 Application Information.....	19
<b>5 Device Comparison Table</b> .....	3	10.2 Typical Application.....	19
<b>6 Pin Configuration and Functions</b> .....	3	<b>11 Power Supply Recommendations</b> .....	21
<b>7 Specifications</b> .....	4	<b>12 Layout</b> .....	21
7.1 Absolute Maximum Ratings.....	4	12.1 Layout Guidelines.....	21
7.2 ESD Ratings.....	4	12.2 Layout Example.....	22
7.3 Recommended Operating Conditions.....	4	<b>13 Device and Documentation Support</b> .....	23
7.4 Thermal Information.....	4	13.1 Documentation Support.....	23
7.5 Electrical Characteristics.....	5	13.2 Related Links.....	23
7.6 Switching Characteristics.....	8	13.3 Receiving Notification of Documentation Updates.....	23
7.7 Typical DC Characteristics.....	9	13.4 Support Resources.....	23
7.8 Typical AC Characteristics (TPS22914B/15B).....	11	13.5 Trademarks.....	23
7.9 Typical AC Characteristics (TPS22914C/15C).....	14	13.6 Electrostatic Discharge Caution.....	23
<b>8 Parameter Measurement Information</b> .....	16	13.7 Glossary.....	23
<b>9 Detailed Description</b> .....	17	<b>14 Mechanical, Packaging, and Orderable Information</b> .....	24
9.1 Overview.....	17		
9.2 Functional Block Diagram.....	17		

## 4 Revision History

NOTE: Page numbers for previous revisions may differ from page numbers in the current version.

<b>Changes from Revision D (September 2016) to Revision E (October 2020)</b>	<b>Page</b>
• Updated the numbering format for tables, figures and cross-references throughout the document.....	1
• Updated the body size in the <i>Device Information</i> table.....	1
<b>Changes from Revision C (July 2015) to Revision D (September 2016)</b>	<b>Page</b>
• Changed "TPS22915B" only, to "TPS22915B/C only" in the <i>Electrical Characteristics</i> table .....	5
<b>Changes from Revision B (September 2014) to Revision C (July 2015)</b>	<b>Page</b>
• Updated $T_A$ ratings in datasheet from 85°C to 105°C.....	1
<b>Changes from Revision A (June 2014) to Revision B (September 2014)</b>	<b>Page</b>
• Updated X-axis scales in th Typical Characteristics section. ....	9
<b>Changes from Revision * (June 2014) to Revision A (June 2014)</b>	<b>Page</b>
• Initial release of full version. ....	1

## 5 Device Comparison Table

DEVICE	R <sub>ON</sub> at 3.3V (TYPICAL)	t <sub>R</sub> at 3.3V (TYPICAL)	QUICK OUTPUT DISCHARGE	MAXIMUM OUTPUT CURRENT	ENABLE
TPS22914B	38 mΩ	64 μs	No	2 A	Active High
TPS22914C	38 mΩ	913 μs	No	2 A	Active High
TPS22915B	38 mΩ	64 μs	Yes	2 A	Active High
TPS22915C	38 mΩ	913 μs	Yes	2 A	Active High

## 6 Pin Configuration and Functions

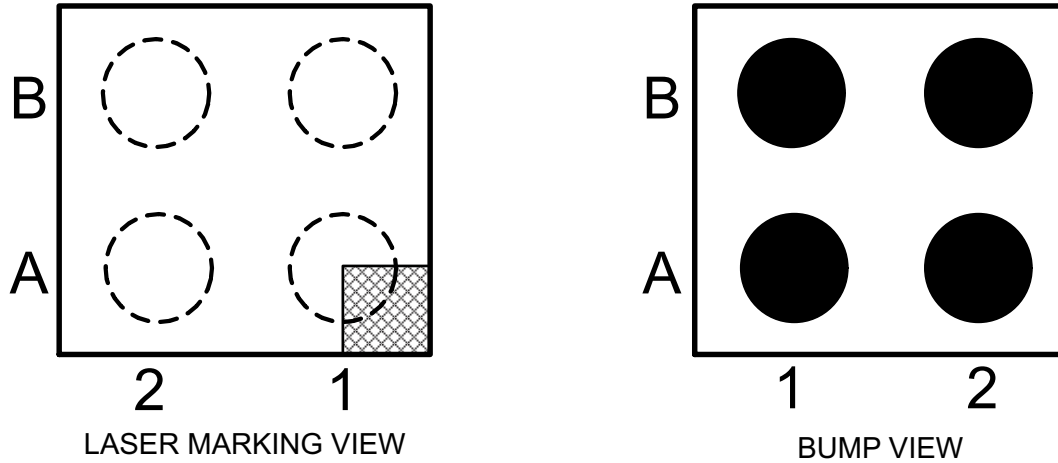


Figure 6-1. YFP PACKAGE 4 PIN DSBGA TOP VIEW

Table 6-1. Pin Description

B	ON	GND
A	VIN	VOUT
	2	1

Table 6-2. Pin Functions

PIN		TYPE	DESCRIPTION
NO.	NAME		
A1	VOUT	O	Switch output. Place ceramic bypass capacitor(s) between this pin and GND. See the <a href="#">Detailed Description</a> section for more information
A2	VIN	I	Switch input. Place ceramic bypass capacitor(s) between this pin and GND. See the <a href="#">Detailed Description</a> section for more information
B1	GND	—	Device ground
B2	ON	I	Active high switch control input. Do not leave floating

## 7 Specifications

### 7.1 Absolute Maximum Ratings

Over operating free-air temperature range (unless otherwise noted)<sup>(1) (2)</sup>

		MIN	MAX	UNIT
V <sub>IN</sub>	Input voltage	-0.3	6	V
V <sub>OUT</sub>	Output voltage	-0.3	6	V
V <sub>ON</sub>	ON voltage	-0.3	6	V
I <sub>MAX</sub>	Maximum continuous switch current		2	A
I <sub>PLS</sub>	Maximum pulsed switch current, pulse < 300 μs, 2% duty cycle		2.5	A
T <sub>J</sub>	Maximum junction temperature		125	°C
T <sub>STG</sub>	Storage temperature	-65	150	°C

- (1) Stresses beyond those listed under *Absolute Maximum Ratings* may cause permanent damage to the device. These are stress ratings only, which do not imply functional operation of the device at these or any other conditions beyond those indicated under *Recommended Operating Conditions*. Exposure to absolute-maximum-rated conditions for extended periods may affect device reliability.
- (2) All voltage values are with respect to network ground terminal.

### 7.2 ESD Ratings

			VALUE	UNIT
V <sub>(ESD)</sub>	Electrostatic discharge	Human-body model (HBM), per ANSI/ESDA/JEDEC JS-001 <sup>(1)</sup>	±2000	V
		Charged-device model (CDM), per JEDEC specification JESD22-C101 <sup>(2)</sup>	±1000	

- (1) JEDEC document JEP155 states that 500-V HBM allows safe manufacturing with a standard ESD control process. Manufacturing with less than 500-V HBM is possible with the necessary precautions.
- (2) JEDEC document JEP157 states that 250-V CDM allows safe manufacturing with a standard ESD control process. Manufacturing with less than 250-V CDM is possible with the necessary precautions.

### 7.3 Recommended Operating Conditions

Over operating free-air temperature range (unless otherwise noted)

			MIN	MAX	UNIT
V <sub>IN</sub>	Input voltage		1.05	5.5	V
V <sub>ON</sub>	ON voltage		0	5.5	V
V <sub>OUT</sub>	Output voltage			V <sub>IN</sub>	V
V <sub>IH, ON</sub>	High-level input voltage, ON	V <sub>IN</sub> = 1.05 V to 5.5 V	1	5.5	V
V <sub>IL, ON</sub>	Low-level input voltage, ON	V <sub>IN</sub> = 1.05 V to 5.5 V	0	0.5	V
T <sub>A</sub>	Operating free-air temperature range <sup>(1)</sup>		-40	105	°C
C <sub>IN</sub>	Input Capacitor		1 <sup>(2)</sup>		μF

- (1) In applications where high power dissipation and/or poor package thermal resistance is present, the maximum ambient temperature may have to be derated. Maximum ambient temperature [T<sub>A(MAX)</sub>] is dependent on the maximum operating junction temperature [T<sub>J(MAX)</sub>], the maximum power dissipation of the device in the application [P<sub>D(MAX)</sub>], and the junction-to-ambient thermal resistance of the part/package in the application (θ<sub>JA</sub>), as given by the following equation: T<sub>A(MAX)</sub> = T<sub>J(MAX)</sub> - (θ<sub>JA</sub> × P<sub>D(MAX)</sub>).
- (2) Refer to the [Detailed Description](#) section.

### 7.4 Thermal Information

THERMAL METRIC <sup>(1)</sup>		TPS2291x	UNIT
		YFP (DSBGA)	
		4 PINS	
R <sub>θJA</sub>	Junction-to-ambient thermal resistance	193	°C/W
R <sub>θJC(top)</sub>	Junction-to-case (top) thermal resistance	2.3	°C/W
R <sub>θJB</sub>	Junction-to-board thermal resistance	36	°C/W
ψ <sub>JT</sub>	Junction-to-top characterization parameter	12	°C/W

### 7.4 Thermal Information (continued)

THERMAL METRIC <sup>(1)</sup>		TPS2291x	UNIT
		YFP (DSBGA)	
		4 PINS	
$\Psi_{JB}$	Junction-to-board characterization parameter	36	°C/W

(1) For more information about traditional and new thermal metrics, see the [Semiconductor and IC Package Thermal Metrics](#) application report.

### 7.5 Electrical Characteristics

Unless otherwise noted, the specification in the following table applies over the operating ambient temperature  $-40^{\circ}\text{C} \leq T_A \leq +105^{\circ}\text{C}$ . **Typical values are for  $T_A = 25^{\circ}\text{C}$ .**

PARAMETER		TEST CONDITION		$T_A$	MIN	TYP	MAX	UNIT	
$I_{Q, VIN}$	Quiescent current (TPS22914B/15B)	$V_{ON} = 5\text{ V}, I_{OUT} = 0\text{ A}$	$V_{IN} = 5.5\text{ V}$	$-40^{\circ}\text{C to } +85^{\circ}\text{C}$		7.7	10.8	$\mu\text{A}$	
				$-40^{\circ}\text{C to } +105^{\circ}\text{C}$			12.1		
			$V_{IN} = 5\text{ V}$	$-40^{\circ}\text{C to } +85^{\circ}\text{C}$		7.6	9.6		
				$-40^{\circ}\text{C to } +105^{\circ}\text{C}$			11.9		
			$V_{IN} = 3.3\text{ V}$	$-40^{\circ}\text{C to } +85^{\circ}\text{C}$		7.7	9.6		
				$-40^{\circ}\text{C to } +105^{\circ}\text{C}$			12		
			$V_{IN} = 1.8\text{ V}$	$-40^{\circ}\text{C to } +85^{\circ}\text{C}$		8.4	11		
	$-40^{\circ}\text{C to } +105^{\circ}\text{C}$				13.5				
	$V_{IN} = 1.2\text{ V}$	$-40^{\circ}\text{C to } +85^{\circ}\text{C}$		7.4	10.4				
		$-40^{\circ}\text{C to } +105^{\circ}\text{C}$			13.9				
	$V_{IN} = 1.05\text{ V}$	$-40^{\circ}\text{C to } +85^{\circ}\text{C}$		6.7	10.9				
		$-40^{\circ}\text{C to } +105^{\circ}\text{C}$			11.7				
	Quiescent current (TPS22914C/15C)	$V_{ON} = 5\text{ V}, I_{OUT} = 0\text{ A}$	$V_{IN} = 5.5\text{ V}$	$-40^{\circ}\text{C to } +85^{\circ}\text{C}$		7.7	11.5		$\mu\text{A}$
				$-40^{\circ}\text{C to } +105^{\circ}\text{C}$			14.1		
$V_{IN} = 5\text{ V}$			$-40^{\circ}\text{C to } +85^{\circ}\text{C}$		7.6	11.1			
			$-40^{\circ}\text{C to } +105^{\circ}\text{C}$			13.7			
$V_{IN} = 3.3\text{ V}$			$-40^{\circ}\text{C to } +85^{\circ}\text{C}$		7.7	10.7			
			$-40^{\circ}\text{C to } +105^{\circ}\text{C}$			13.3			
$V_{IN} = 1.8\text{ V}$			$-40^{\circ}\text{C to } +85^{\circ}\text{C}$		8.4	11.7			
			$-40^{\circ}\text{C to } +105^{\circ}\text{C}$			13.4			
$V_{IN} = 1.2\text{ V}$			$-40^{\circ}\text{C to } +85^{\circ}\text{C}$		7.4	11			
			$-40^{\circ}\text{C to } +105^{\circ}\text{C}$			12.8			
$V_{IN} = 1.05\text{ V}$	$-40^{\circ}\text{C to } +85^{\circ}\text{C}$		6.7	10.9					
	$-40^{\circ}\text{C to } +105^{\circ}\text{C}$			10.9					

## 7.5 Electrical Characteristics (continued)

Unless otherwise noted, the specification in the following table applies over the operating ambient temperature  $-40^{\circ}\text{C} \leq T_A \leq +105^{\circ}\text{C}$ . **Typical values are for  $T_A = 25^{\circ}\text{C}$ .**

PARAMETER		TEST CONDITION		$T_A$	MIN	TYP	MAX	UNIT			
$I_{SD, V_{IN}}$	Shutdown current	$V_{ON} = 0\text{ V}, V_{OUT} = 0\text{ V}$	$V_{IN} = 5.5\text{ V}$	$-40^{\circ}\text{C to }+85^{\circ}\text{C}$		0.5	2	$\mu\text{A}$			
				$-40^{\circ}\text{C to }+105^{\circ}\text{C}$			3				
			$V_{IN} = 5.0\text{ V}$	$-40^{\circ}\text{C to }+85^{\circ}\text{C}$		0.5	2				
				$-40^{\circ}\text{C to }+105^{\circ}\text{C}$			3				
			$V_{IN} = 3.3\text{ V}$	$-40^{\circ}\text{C to }+85^{\circ}\text{C}$		0.5	2				
				$-40^{\circ}\text{C to }+105^{\circ}\text{C}$			3				
			$V_{IN} = 1.8\text{ V}$	$-40^{\circ}\text{C to }+85^{\circ}\text{C}$		0.5	2				
				$-40^{\circ}\text{C to }+105^{\circ}\text{C}$			3				
			$V_{IN} = 1.2\text{ V}$	$-40^{\circ}\text{C to }+85^{\circ}\text{C}$		0.4	2				
				$-40^{\circ}\text{C to }+105^{\circ}\text{C}$			3				
			$V_{IN} = 1.05\text{ V}$	$-40^{\circ}\text{C to }+85^{\circ}\text{C}$		0.4	2				
				$-40^{\circ}\text{C to }+105^{\circ}\text{C}$			3				
			$I_{ON}$	ON pin input leakage current	$V_{IN} = 5.5\text{ V}, I_{OUT} = 0\text{ A}$	$-40^{\circ}\text{C to }+105^{\circ}\text{C}$				0.1	$\mu\text{A}$
			$R_{ON}$	On-resistance	$I_{OUT} = -200\text{ mA}$	$V_{IN} = 5.5\text{ V}$	$25^{\circ}\text{C}$			37	40
$-40^{\circ}\text{C to }+85^{\circ}\text{C}$							51				
$-40^{\circ}\text{C to }+105^{\circ}\text{C}$							57				
$V_{IN} = 5\text{ V}$	$25^{\circ}\text{C}$					37	41	$\text{m}\Omega$			
	$-40^{\circ}\text{C to }+85^{\circ}\text{C}$						51				
	$-40^{\circ}\text{C to }+105^{\circ}\text{C}$						57				
$V_{IN} = 4.2\text{ V}$	$25^{\circ}\text{C}$					37	41	$\text{m}\Omega$			
	$-40^{\circ}\text{C to }+85^{\circ}\text{C}$						52				
	$-40^{\circ}\text{C to }+105^{\circ}\text{C}$						58				
$V_{IN} = 3.3\text{ V}$	$25^{\circ}\text{C}$					38	41	$\text{m}\Omega$			
	$-40^{\circ}\text{C to }+85^{\circ}\text{C}$						52				
	$-40^{\circ}\text{C to }+105^{\circ}\text{C}$						59				
$V_{IN} = 2.5\text{ V}$	$25^{\circ}\text{C}$					38	42	$\text{m}\Omega$			
	$-40^{\circ}\text{C to }+85^{\circ}\text{C}$						53				
	$-40^{\circ}\text{C to }+105^{\circ}\text{C}$						58				
$V_{IN} = 1.8\text{ V}$	$25^{\circ}\text{C}$					43	48	$\text{m}\Omega$			
	$-40^{\circ}\text{C to }+85^{\circ}\text{C}$						59				
	$-40^{\circ}\text{C to }+105^{\circ}\text{C}$						66				
$V_{IN} = 1.2\text{ V}$	$25^{\circ}\text{C}$					52	61	$\text{m}\Omega$			
	$-40^{\circ}\text{C to }+85^{\circ}\text{C}$						73				
	$-40^{\circ}\text{C to }+105^{\circ}\text{C}$						85				
$V_{IN} = 1.05\text{ V}$	$25^{\circ}\text{C}$					63	96	$\text{m}\Omega$			
	$-40^{\circ}\text{C to }+85^{\circ}\text{C}$						102				
	$-40^{\circ}\text{C to }+105^{\circ}\text{C}$						107				

## 7.5 Electrical Characteristics (continued)

Unless otherwise noted, the specification in the following table applies over the operating ambient temperature  $-40^{\circ}\text{C} \leq T_A \leq +105^{\circ}\text{C}$ . **Typical values are for  $T_A = 25^{\circ}\text{C}$ .**

PARAMETER		TEST CONDITION	$T_A$	MIN	TYP	MAX	UNIT
$V_{\text{HYS}}$	ON pin hysteresis	$V_{\text{IN}} = 5.5 \text{ V}$	25°C		102		mV
		$V_{\text{IN}} = 5 \text{ V}$			100		
		$V_{\text{IN}} = 3.3 \text{ V}$			98		
		$V_{\text{IN}} = 2.5 \text{ V}$			96		
		$V_{\text{IN}} = 1.8 \text{ V}$			96		
		$V_{\text{IN}} = 1.2 \text{ V}$			94		
		$V_{\text{IN}} = 1.05 \text{ V}$			92		
$R_{\text{PD}}$ <sup>(1)</sup>	Output pull down resistor	$V_{\text{IN}} = V_{\text{OUT}} = 3.3 \text{ V}, V_{\text{ON}} = 0 \text{ V}$	$-40^{\circ}\text{C}$ to $+105^{\circ}\text{C}$		143	200	$\Omega$

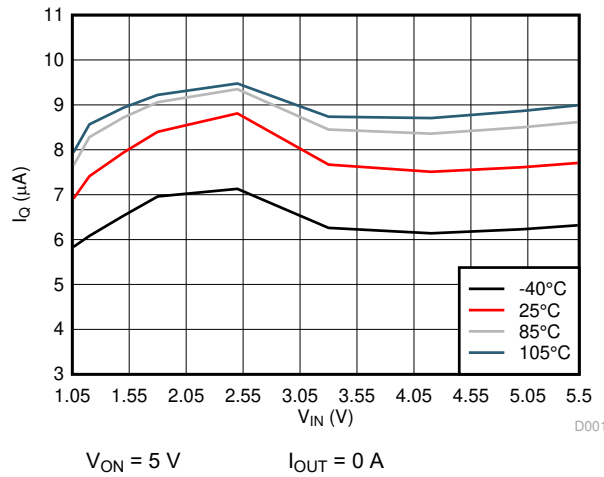
(1) TPS22915B/C only.

## 7.6 Switching Characteristics

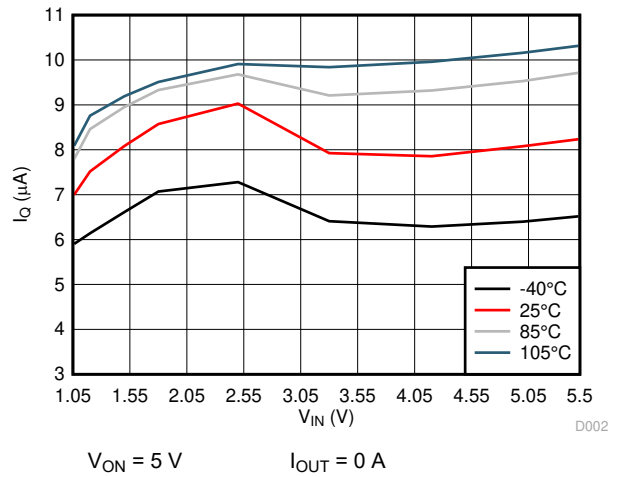
Refer to the timing test circuit in [Figure 8-1](#) (unless otherwise noted) for references to external components used for the test condition in the switching characteristics table. Switching characteristics shown below are only valid for the power-up sequence where  $V_{IN}$  is already in steady state condition before the ON pin is asserted high.

PARAMETER		TEST CONDITION	TYP (TPS22914B/15B)	TYP (TPS22914C/15C)	UNIT
<b><math>V_{IN} = 5\text{ V}</math>, <math>V_{ON} = 5\text{ V}</math>, <math>T_A = 25^\circ\text{C}</math> (unless otherwise noted)</b>					
$t_{ON}$	Turnon time	$R_L = 10\ \Omega$ , $C_{IN} = 1\ \mu\text{F}$ , $C_{OUT} = 0.1\ \mu\text{F}$	104	1300	$\mu\text{s}$
$t_{OFF}$	Turnoff time	$R_L = 10\ \Omega$ , $C_{IN} = 1\ \mu\text{F}$ , $C_{OUT} = 0.1\ \mu\text{F}$	2	2	$\mu\text{s}$
$t_R$	$V_{OUT}$ rise time	$R_L = 10\ \Omega$ , $C_{IN} = 1\ \mu\text{F}$ , $C_{OUT} = 0.1\ \mu\text{F}$	89	1277	$\mu\text{s}$
$t_F$	$V_{OUT}$ fall time	$R_L = 10\ \Omega$ , $C_{IN} = 1\ \mu\text{F}$ , $C_{OUT} = 0.1\ \mu\text{F}$	2	2	$\mu\text{s}$
$t_D$	Delay time	$R_L = 10\ \Omega$ , $C_{IN} = 1\ \mu\text{F}$ , $C_{OUT} = 0.1\ \mu\text{F}$	59	663	$\mu\text{s}$
<b><math>V_{IN} = 3.3\text{ V}</math>, <math>V_{ON} = 5\text{ V}</math>, <math>T_A = 25^\circ\text{C}</math> (unless otherwise noted)</b>					
$t_{ON}$	Turnon time	$R_L = 10\ \Omega$ , $C_{IN} = 1\ \mu\text{F}$ , $C_{OUT} = 0.1\ \mu\text{F}$	83	1077	$\mu\text{s}$
$t_{OFF}$	Turnoff time	$R_L = 10\ \Omega$ , $C_{IN} = 1\ \mu\text{F}$ , $C_{OUT} = 0.1\ \mu\text{F}$	2	2	$\mu\text{s}$
$t_R$	$V_{OUT}$ rise time	$R_L = 10\ \Omega$ , $C_{IN} = 1\ \mu\text{F}$ , $C_{OUT} = 0.1\ \mu\text{F}$	64	913	$\mu\text{s}$
$t_F$	$V_{OUT}$ fall time	$R_L = 10\ \Omega$ , $C_{IN} = 1\ \mu\text{F}$ , $C_{OUT} = 0.1\ \mu\text{F}$	2	2	$\mu\text{s}$
$t_D$	Delay time	$R_L = 10\ \Omega$ , $C_{IN} = 1\ \mu\text{F}$ , $C_{OUT} = 0.1\ \mu\text{F}$	52	622	$\mu\text{s}$
<b><math>V_{IN} = 1.05\text{ V}</math>, <math>V_{ON} = 5\text{ V}</math>, <math>T_A = 25^\circ\text{C}</math> (unless otherwise noted)</b>					
$t_{ON}$	Turnon time	$R_L = 10\ \Omega$ , $C_{IN} = 1\ \mu\text{F}$ , $C_{OUT} = 0.1\ \mu\text{F}$	61	752	$\mu\text{s}$
$t_{OFF}$	Turnoff time	$R_L = 10\ \Omega$ , $C_{IN} = 1\ \mu\text{F}$ , $C_{OUT} = 0.1\ \mu\text{F}$	3	3	$\mu\text{s}$
$t_R$	$V_{OUT}$ rise time	$R_L = 10\ \Omega$ , $C_{IN} = 1\ \mu\text{F}$ , $C_{OUT} = 0.1\ \mu\text{F}$	28	409	$\mu\text{s}$
$t_F$	$V_{OUT}$ fall time	$R_L = 10\ \Omega$ , $C_{IN} = 1\ \mu\text{F}$ , $C_{OUT} = 0.1\ \mu\text{F}$	2	2	$\mu\text{s}$
$t_D$	Delay time	$R_L = 10\ \Omega$ , $C_{IN} = 1\ \mu\text{F}$ , $C_{OUT} = 0.1\ \mu\text{F}$	47	547	$\mu\text{s}$

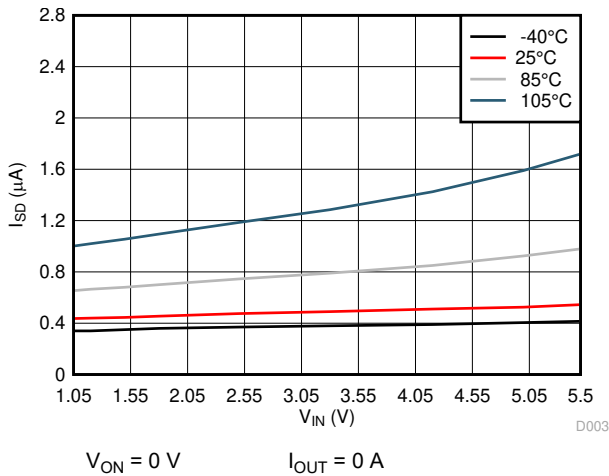
## 7.7 Typical DC Characteristics



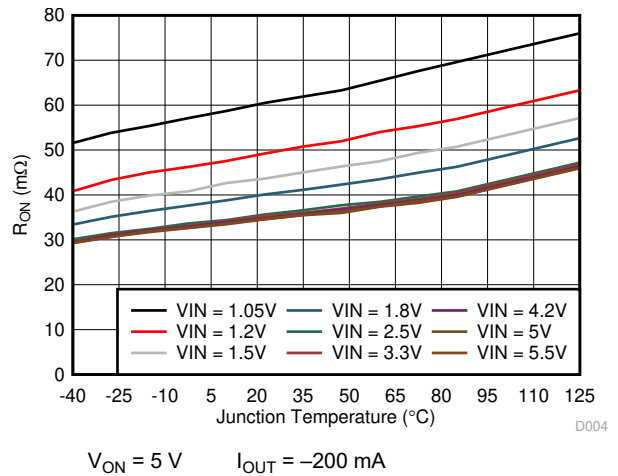
**Figure 7-1.  $I_Q$  vs  $V_{IN}$  (TPS22914B/15B)**



**Figure 7-2.  $I_Q$  vs  $V_{IN}$  (TPS22914C/15C)**



**Figure 7-3.  $I_{SD}$  vs  $V_{IN}$**



**Figure 7-4.  $R_{ON}$  vs  $T_J$**

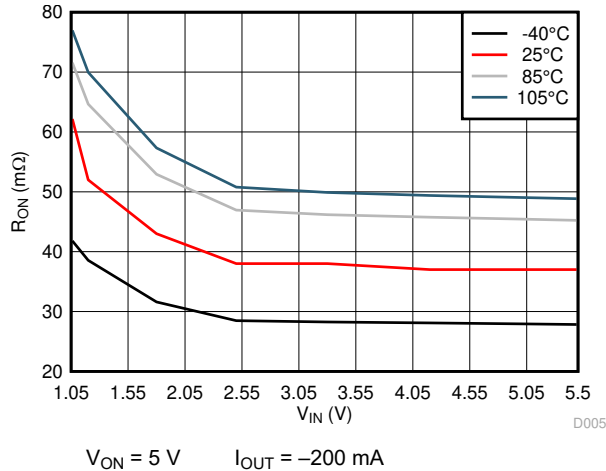


Figure 7-5.  $R_{ON}$  vs  $V_{IN}$

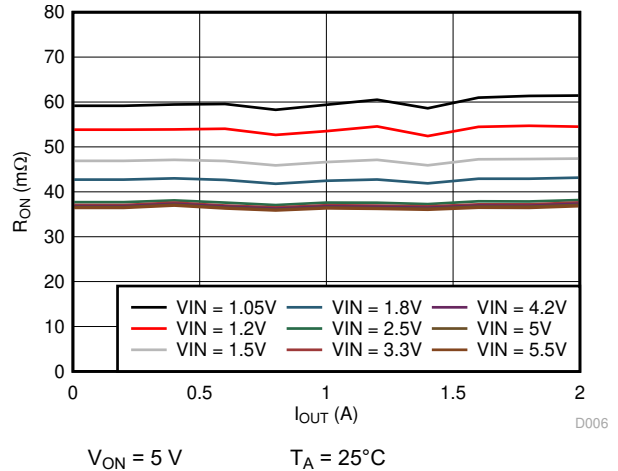


Figure 7-6.  $R_{ON}$  vs  $I_{OUT}$

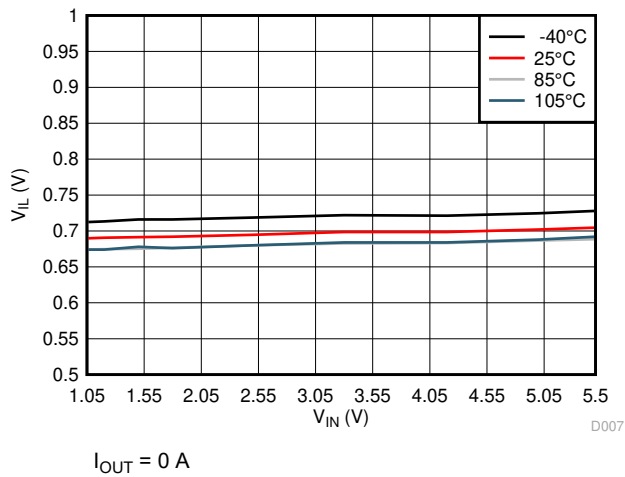


Figure 7-7.  $V_{IL}$  vs  $V_{IN}$

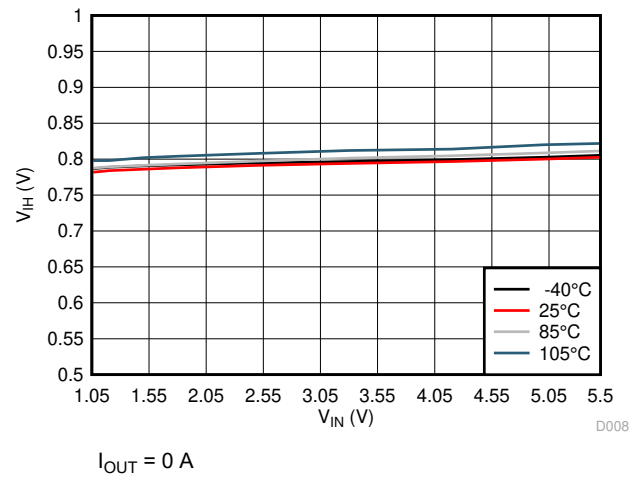


Figure 7-8.  $V_{IH}$  vs  $V_{IN}$

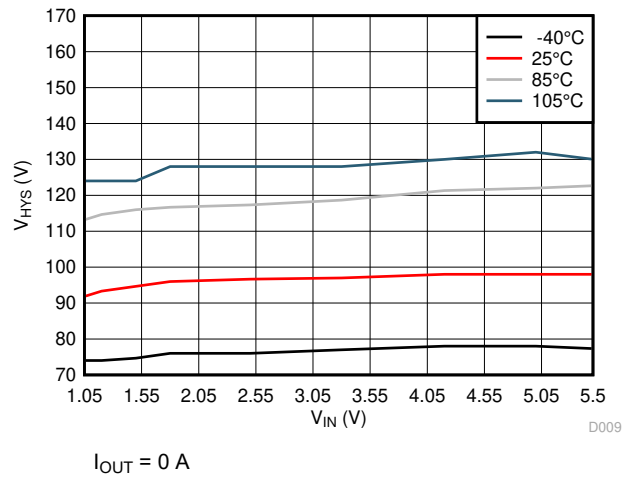


Figure 7-9.  $V_{HYS}$  vs  $V_{IN}$

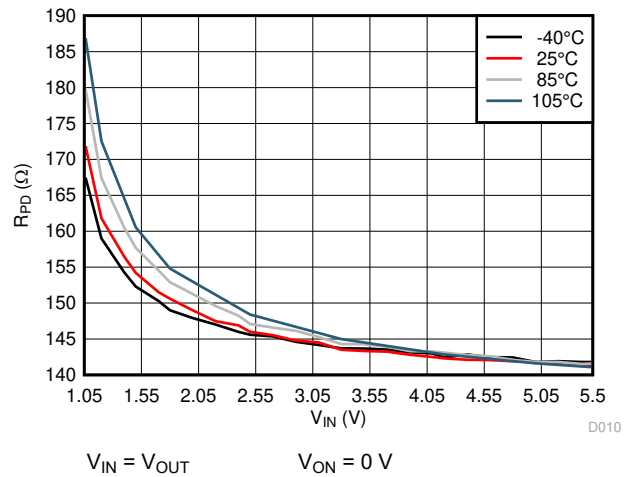
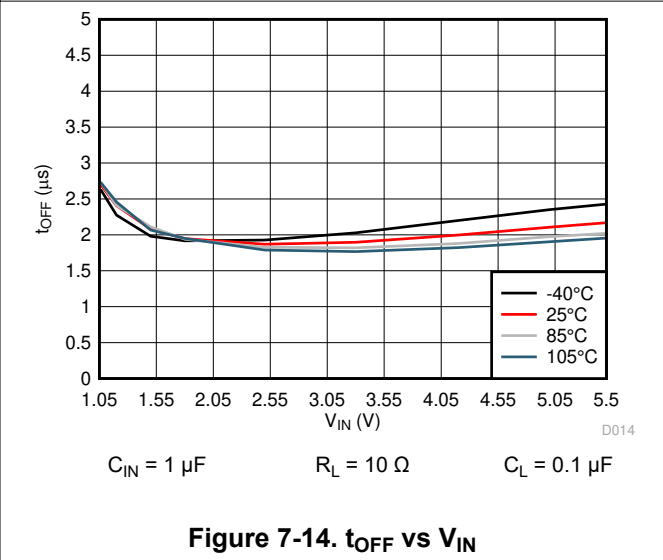
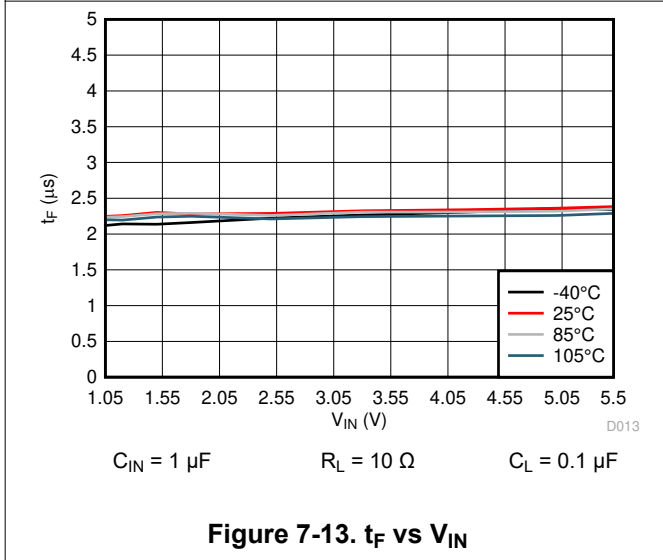
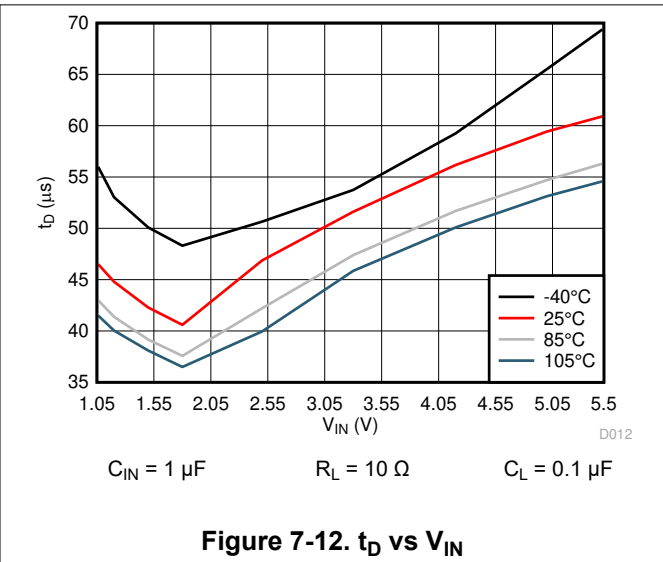
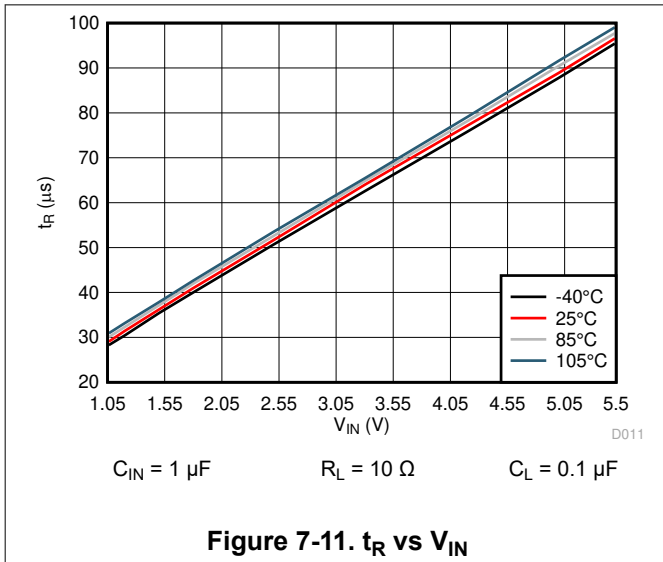


Figure 7-10.  $R_{PD}$  vs  $V_{IN}$

### 7.8 Typical AC Characteristics (TPS22914B/15B)



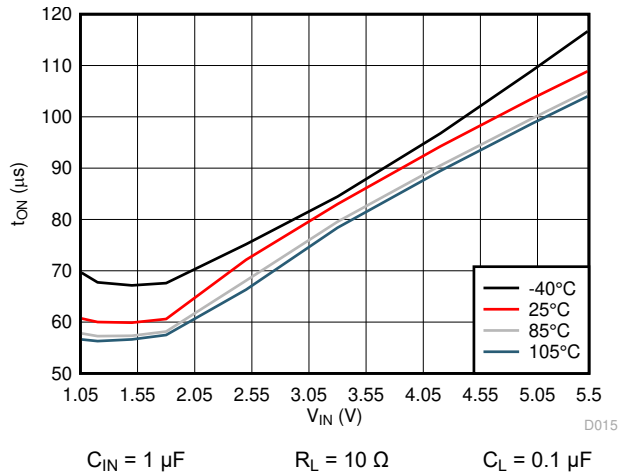


Figure 7-15.  $t_{ON}$  vs  $V_{IN}$

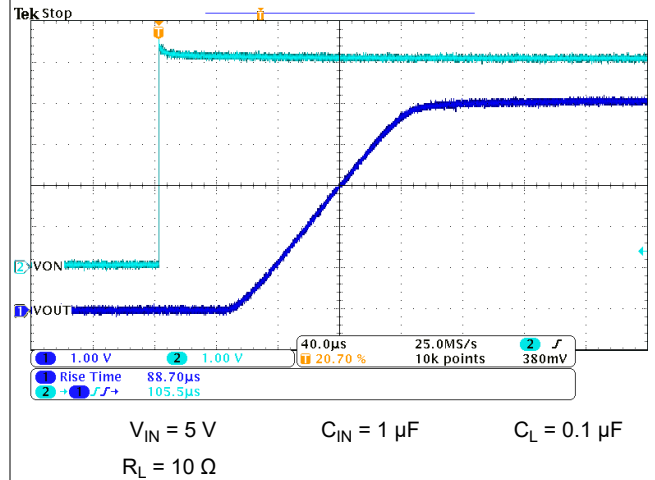


Figure 7-16.  $t_R$  at  $V_{IN} = 5 V$

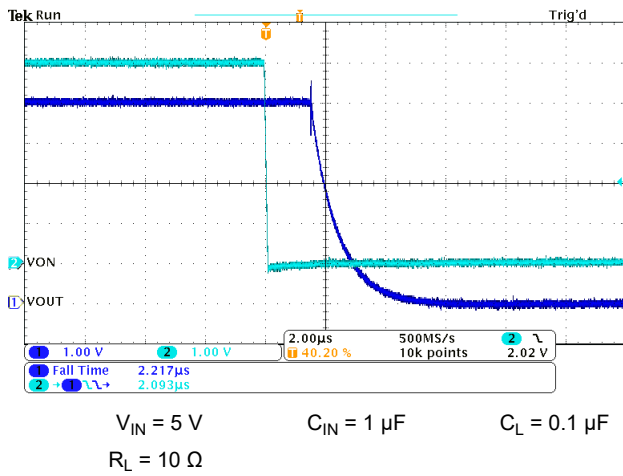


Figure 7-17.  $t_F$  at  $V_{IN} = 5 V$

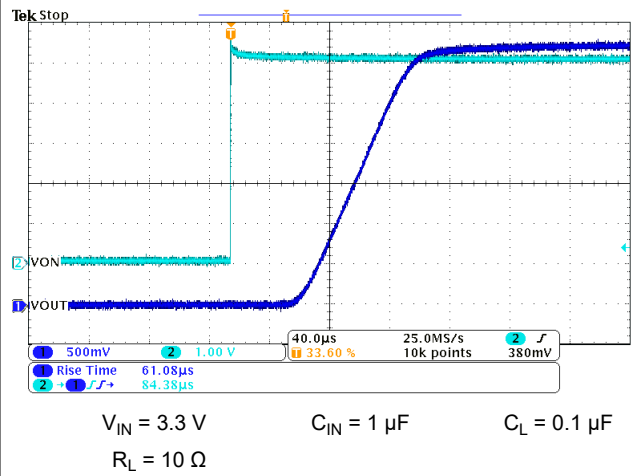


Figure 7-18.  $t_R$  at  $V_{IN} = 3.3 V$

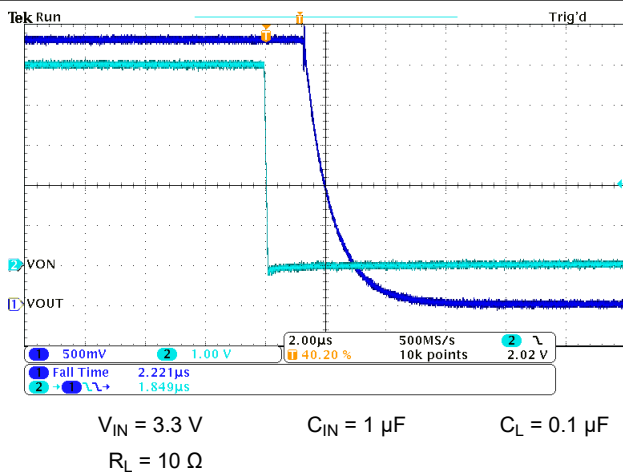


Figure 7-19.  $t_F$  at  $V_{IN} = 3.3V$

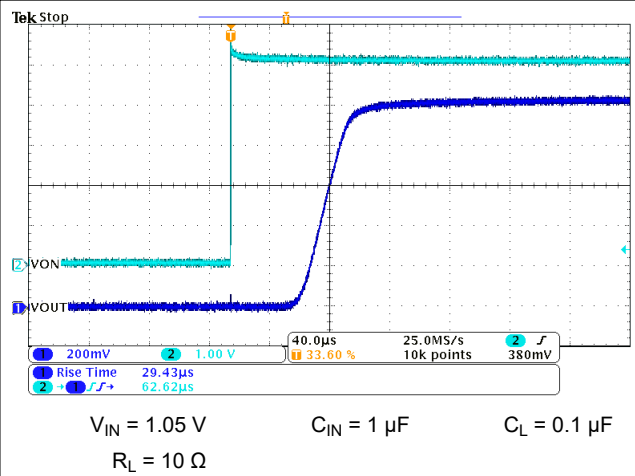
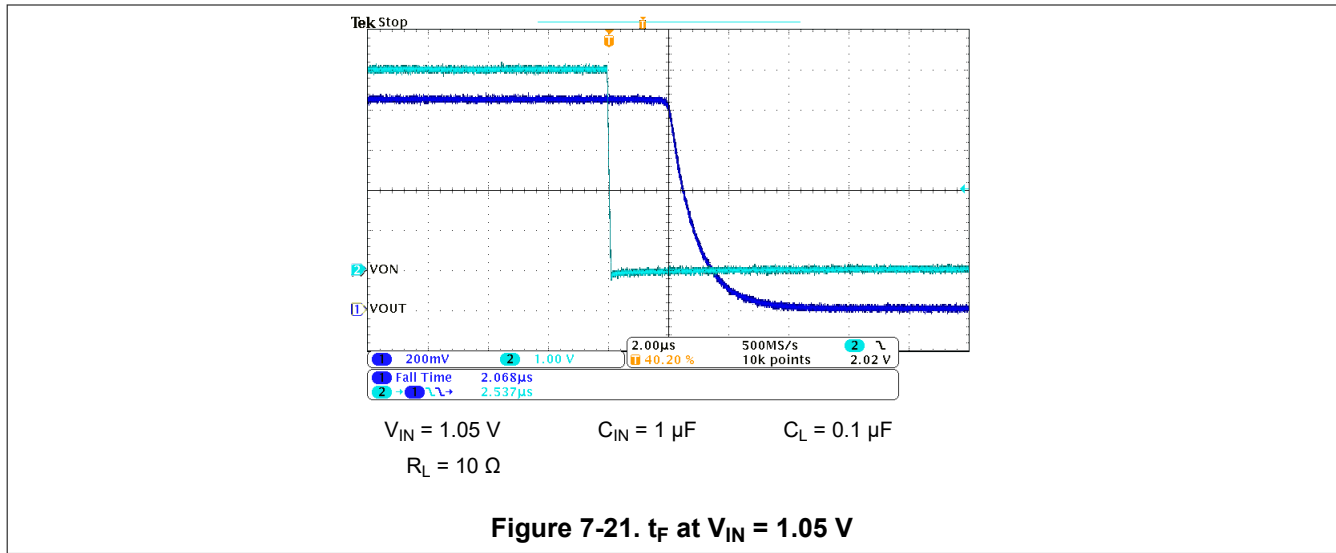
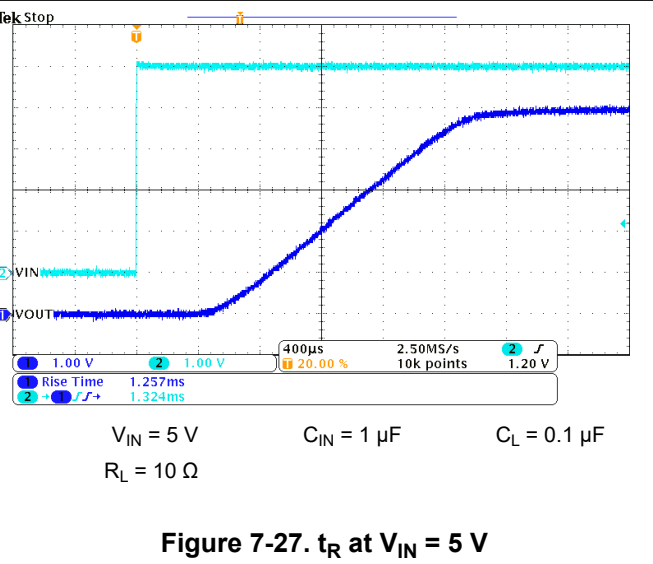
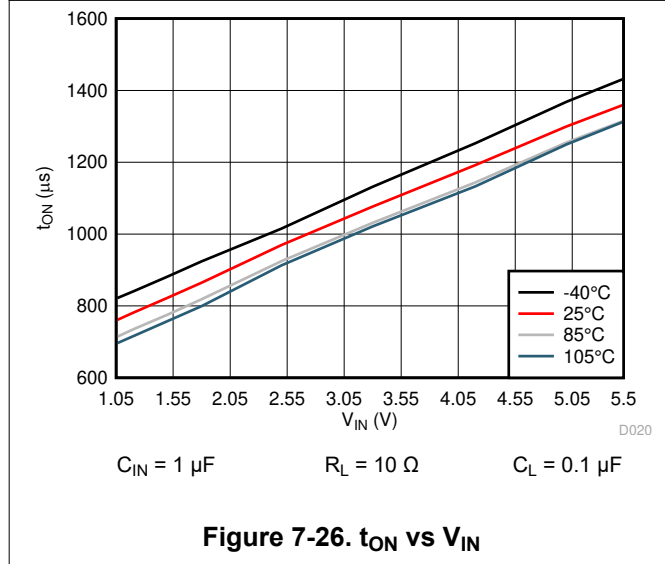
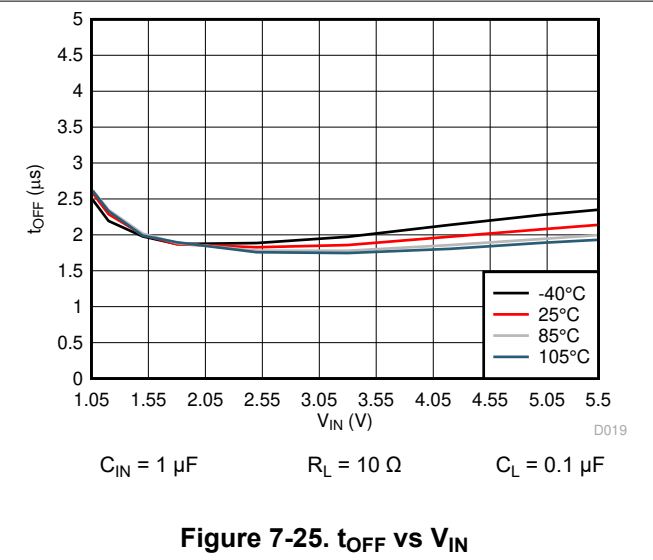
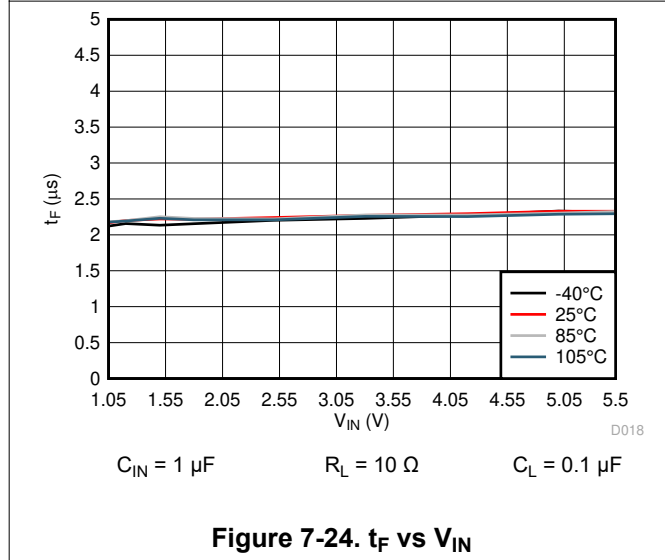
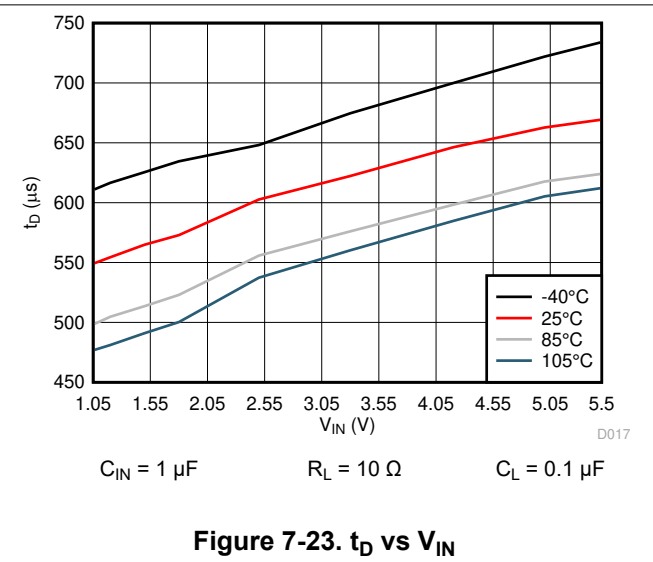
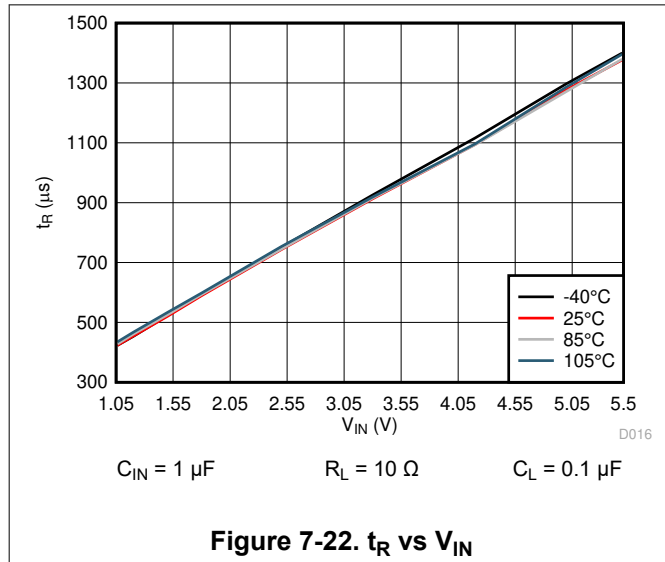
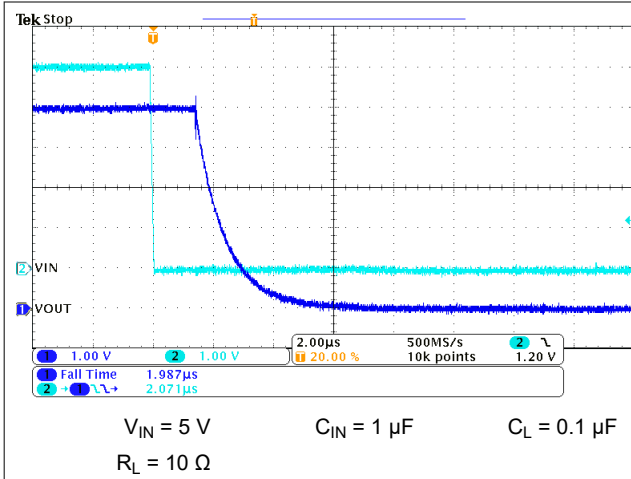


Figure 7-20.  $t_R$  at  $V_{IN} = 1.05V$

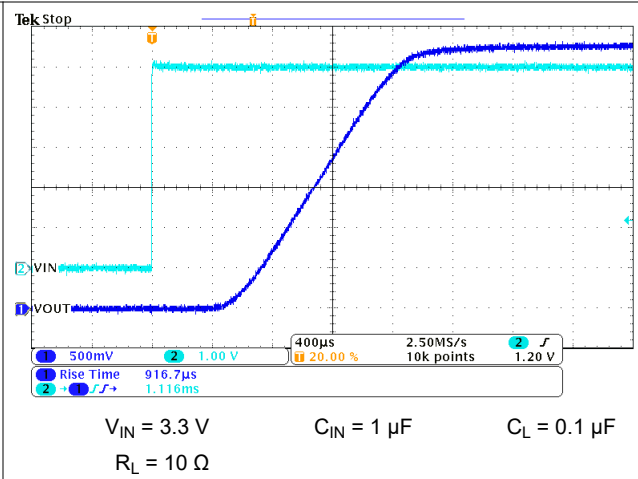


## 7.9 Typical AC Characteristics (TPS22914C/15C)

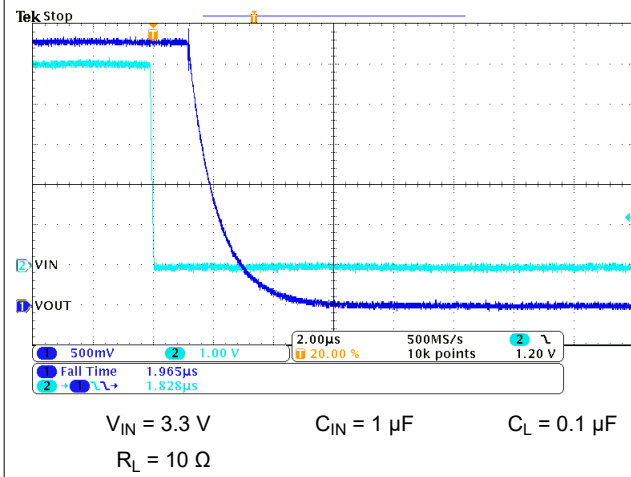




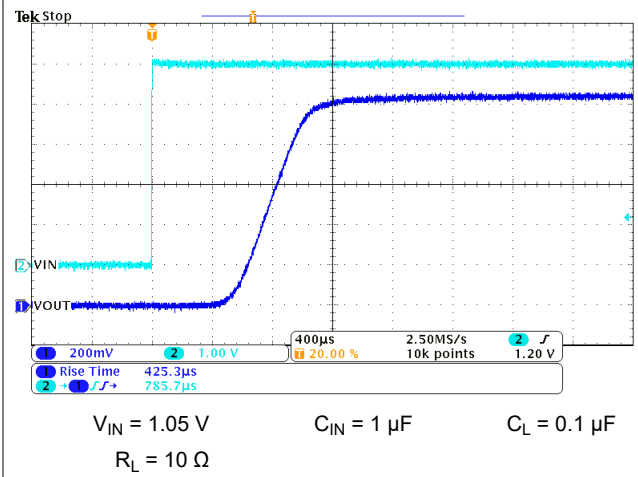
**Figure 7-28.  $t_F$  at  $V_{IN} = 5\text{ V}$**



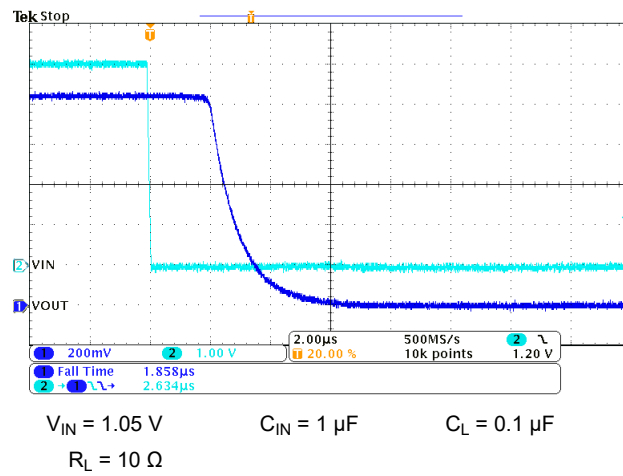
**Figure 7-29.  $t_R$  at  $V_{IN} = 3.3\text{ V}$**



**Figure 7-30.  $t_F$  at  $V_{IN} = 3.3\text{ V}$**

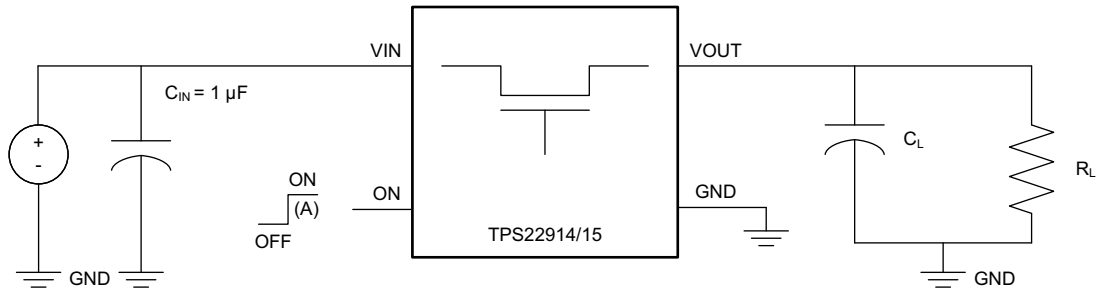


**Figure 7-31.  $t_R$  at  $V_{IN} = 1.05\text{ V}$**



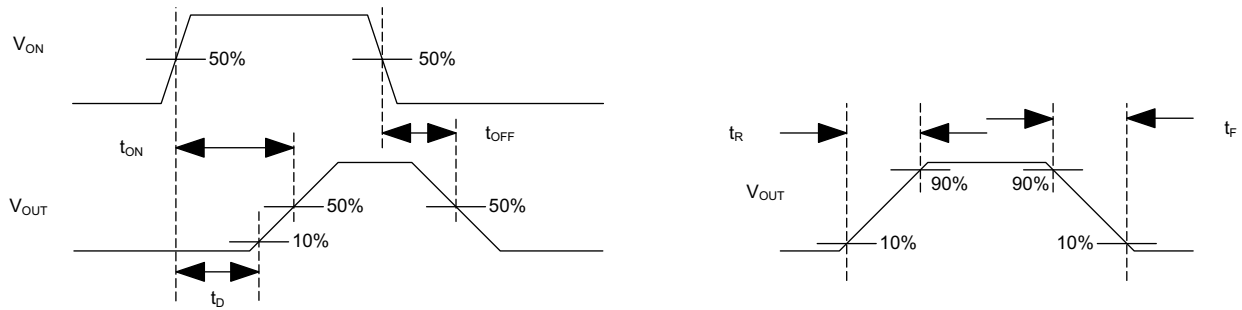
**Figure 7-32.  $t_F$  at  $V_{IN} = 1.05\text{ V}$**

## 8 Parameter Measurement Information



A. Rise and fall times of the control signal is 100ns

**Figure 8-1. Test Circuit**



**Figure 8-2. Timing Waveforms**

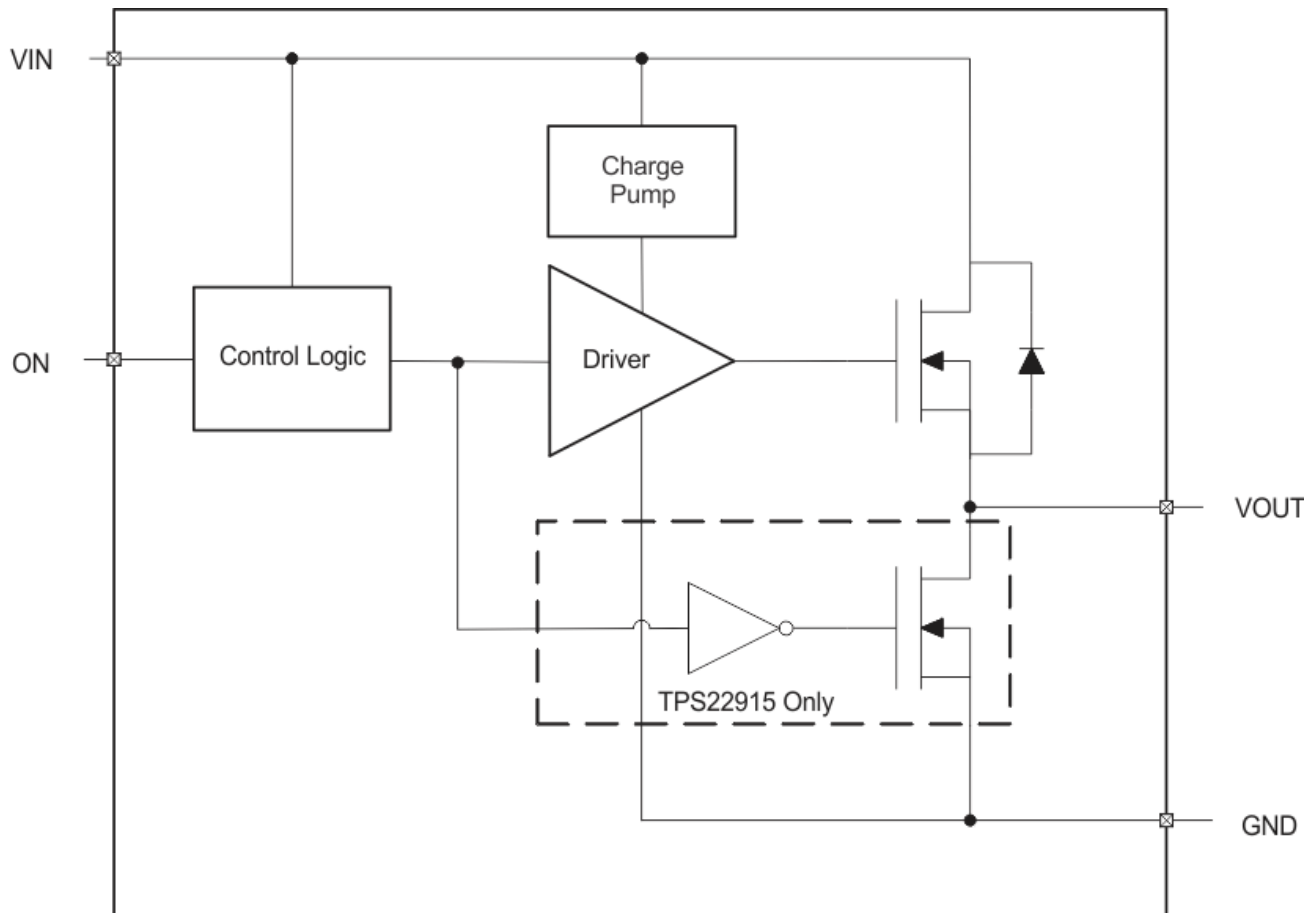
## 9 Detailed Description

### 9.1 Overview

The device is a 5.5-V, 2-A load switch in a 4-pin YFP package. To reduce voltage drop for low voltage and high current rails, the device implements an ultra-low resistance N-channel MOSFET which reduces the drop out voltage through the device.

The device has a controlled and fixed slew rate which helps reduce or eliminate power supply droop due to large inrush currents. During shutdown, the device has very low leakage currents, thereby reducing unnecessary leakages for downstream modules during standby. Integrated control logic, driver, charge pump, and output discharge FET eliminates the need for any external components, which reduces solution size and bill of materials (BOM) count.

### 9.2 Functional Block Diagram



### 9.3 Feature Description

#### 9.3.1 On and Off Control

The ON pins control the state of the switch. Asserting ON high enables the switch. ON is active high and has a low threshold, making it capable of interfacing with low-voltage signals. The ON pin is compatible with standard GPIO logic threshold. It can be used with any microcontroller with 1 V or higher GPIO voltage. This pin cannot be left floating and must be driven either high or low for proper functionality.

#### 9.3.2 Input Capacitor ( $C_{IN}$ )

To limit the voltage drop on the input supply caused by transient in-rush currents when the switch turns on into a discharged load capacitor or short-circuit, a capacitor needs to be placed between VIN and GND. A 1- $\mu$ F

ceramic capacitor,  $C_{IN}$ , placed close to the pins, is usually sufficient. Higher values of  $C_{IN}$  can be used to further reduce the voltage drop during high-current application. When switching heavy loads, it is recommended to have an input capacitor about 10 times higher than the output capacitor to avoid excessive voltage drop.

### 9.3.3 Output Capacitor ( $C_L$ )

Due to the integrated body diode in the MOSFET, a  $C_{IN}$  greater than  $C_L$  is highly recommended. A  $C_L$  greater than  $C_{IN}$  can cause  $V_{OUT}$  to exceed  $V_{IN}$  when the system supply is removed. This could result in current flow through the body diode from  $V_{OUT}$  to  $V_{IN}$ . A  $C_{IN}$  to  $C_L$  ratio of 10 to 1 is recommended for minimizing  $V_{IN}$  dip caused by inrush currents during startup.

## 9.4 Device Functional Modes

[Table 9-1](#) describes the connection of the  $V_{OUT}$  pin depending on the state of the ON pin.

**Table 9-1. VOUT Connection**

ON	TPS22914	TPS22915
L	Open	GND
H	VIN	VIN

## 10 Application and Implementation

### Note

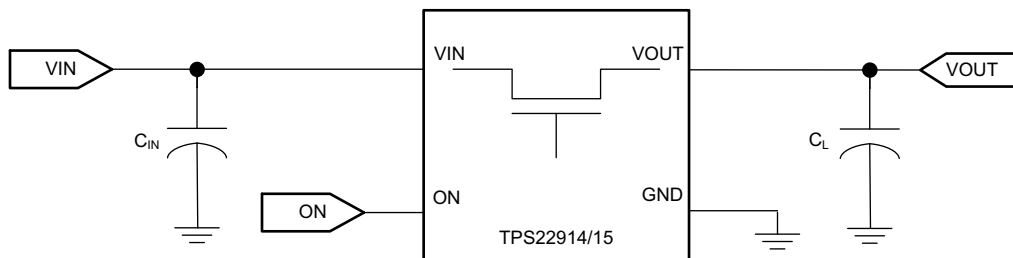
Information in the following applications sections is not part of the TI component specification, and TI does not warrant its accuracy or completeness. TI's customers are responsible for determining suitability of components for their purposes. Customers should validate and test their design implementation to confirm system functionality.

### 10.1 Application Information

This section highlights some of the design considerations when implementing this device in various applications. A PSPICE model for this device is also available in the product page of this device.

### 10.2 Typical Application

This typical application demonstrates how the TPS22914 and TPS22915 can be used to power downstream modules.



**Figure 10-1. Typical Application Schematic**

#### 10.2.1 Design Requirements

For this design example, use the input parameters shown in [Table 10-1](#).

**Table 10-1. Design Parameters**

DESIGN PARAMETER	EXAMPLE VALUE
$V_{IN}$	5 V
Load current	2 A

## 10.2.2 Detailed Design Procedure

To begin the design process, the designer needs to know the following:

- $V_{IN}$  voltage
- Load Current

### 10.2.2.1 $V_{IN}$ to $V_{OUT}$ Voltage Drop

The  $V_{IN}$  to  $V_{OUT}$  voltage drop in the device is determined by the  $R_{ON}$  of the device and the load current. The  $R_{ON}$  of the device depends upon the  $V_{IN}$  conditions of the device. Refer to the  $R_{ON}$  specification of the device in the [Electrical Characteristics](#) table of this datasheet. Once the  $R_{ON}$  of the device is determined based upon the  $V_{IN}$  conditions, use [Equation 1](#) to calculate the  $V_{IN}$  to  $V_{OUT}$  voltage drop.

$$\Delta V = I_{LOAD} \times R_{ON} \quad (1)$$

where

- $\Delta V$  = voltage drop from  $V_{IN}$  to  $V_{OUT}$
- $I_{LOAD}$  = load current
- $R_{ON}$  = On-resistance of the device for a specific  $V_{IN}$

An appropriate  $I_{LOAD}$  must be chosen such that the  $I_{MAX}$  specification of the device is not violated.

### 10.2.2.2 Inrush Current

To determine how much inrush current is caused by the  $C_L$  capacitor, use [Equation 2](#).

$$I_{INRUSH} = C_L \times \frac{dV_{OUT}}{dt} \quad (2)$$

where

- $I_{INRUSH}$  = amount of inrush caused by  $C_L$
- $C_L$  = capacitance on  $V_{OUT}$
- $dt$  = rise time in  $V_{OUT}$  during the ramp up of  $V_{OUT}$  when the device is enabled
- $dV_{OUT}$  = change in  $V_{OUT}$  during the ramp up of  $V_{OUT}$  when the device is enabled

An appropriate  $C_L$  value must be placed on  $V_{OUT}$  such that the  $I_{MAX}$  and  $I_{PLS}$  specifications of the device are not violated.

## 10.2.3 Application Curves

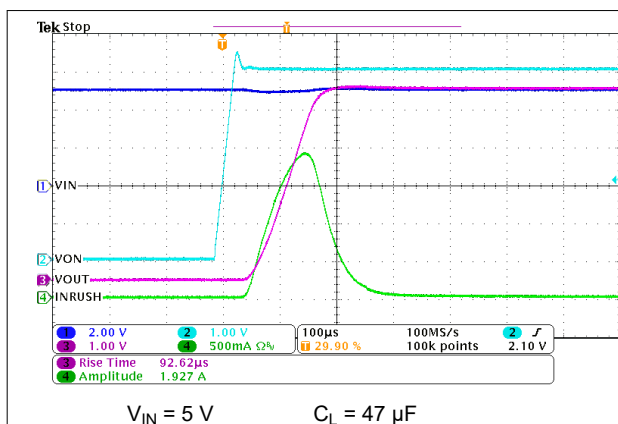


Figure 10-2. TPS22914B/15B Inrush Current

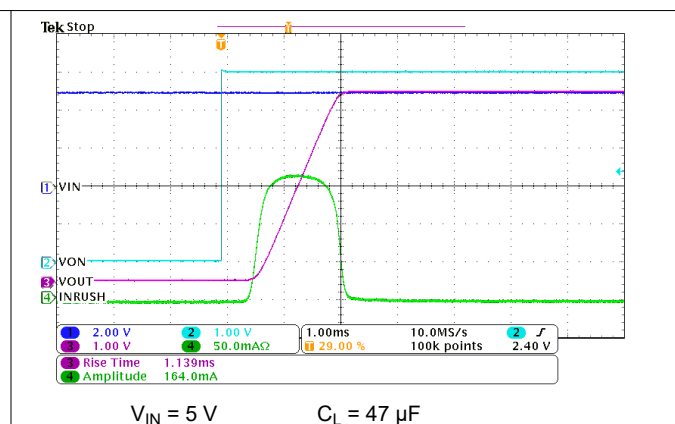


Figure 10-3. TPS22914C/15C Inrush Current

## 11 Power Supply Recommendations

The device is designed to operate from a VIN range of 1.05 V to 5.5 V. This supply must be well regulated and placed as close to the device terminal as possible with the recommended 1-μF bypass capacitor. If the supply is located more than a few inches from the device terminals, additional bulk capacitance may be required in addition to the ceramic bypass capacitors. If additional bulk capacitance is required, an electrolytic, tantalum, or ceramic capacitor of 1 μF may be sufficient.

## 12 Layout

### 12.1 Layout Guidelines

1. VIN and VOUT traces must be as short and wide as possible to accommodate for high current.
2. The VIN pin must be bypassed to ground with low ESR ceramic bypass capacitors. The typical recommended bypass capacitance is 1-μF ceramic with X5R or X7R dielectric. This capacitor must be placed as close to the device pins as possible.
3. The VOUT pin must be bypassed to ground with low ESR ceramic bypass capacitors. The typical recommended bypass capacitance is one-tenth of the VIN bypass capacitor of X5R or X7R dielectric rating. This capacitor must be placed as close to the device pins as possible.

#### 12.1.1 Thermal Considerations

For best performance, all traces must be as short as possible. To be most effective, the input and output capacitors must be placed close to the device to minimize the effects that parasitic trace inductances may have on normal and short-circuit operation. Using wide traces for VIN, VOUT, and GND helps minimize the parasitic electrical effects along with minimizing the case to ambient thermal impedance.

The maximum IC junction temperature must be restricted to 125°C under normal operating conditions. To calculate the maximum allowable dissipation,  $P_{D(\text{max})}$  for a given output current and ambient temperature, use [Equation 3](#).

$$P_{D(\text{MAX})} = \frac{T_{J(\text{MAX})} - T_A}{\theta_{JA}} \quad (3)$$

where

- $P_{D(\text{MAX})}$  = maximum allowable power dissipation
- $T_{J(\text{MAX})}$  = maximum allowable junction temperature (125°C for the TPS22914/15)
- $T_A$  = ambient temperature of the device
- $\theta_{JA}$  = junction to air thermal impedance. Refer to the [Thermal Information](#) table. This parameter is highly dependent upon board layout.

## 12.2 Layout Example

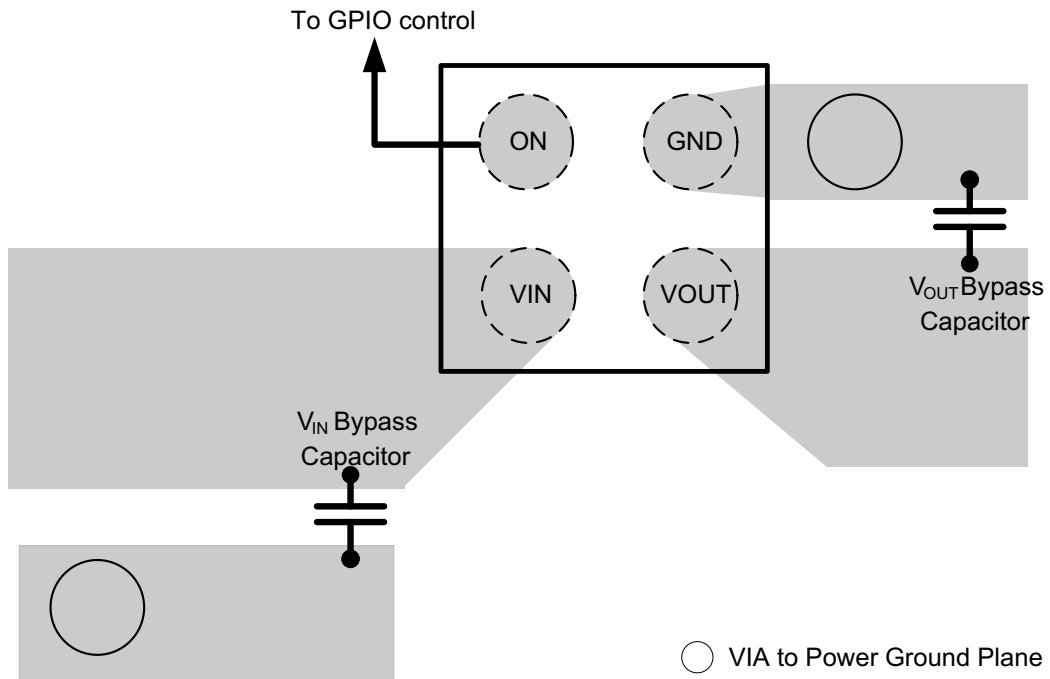


Figure 12-1. Recommended Board Layout

## 13 Device and Documentation Support

### 13.1 Documentation Support

#### 13.1.1 Related Documentation

For related documentation see the following:

- [Basics of Load Switches](#)
- [Managing Inrush Current](#)
- [Load Switch Thermal Considerations](#)
- [Using the TPS22915BEVM-078 Single Channel Load Switch IC](#)
- [Implementing Ship Mode Using the TPS22915B Load Switches](#)

#### 13.2 Related Links

The table below lists quick access links. Categories include technical documents, support and community resources, tools and software, and quick access to sample or buy.

**Table 13-1. Related Links**

PARTS	PRODUCT FOLDER	SAMPLE & BUY	TECHNICAL DOCUMENTS	TOOLS & SOFTWARE	SUPPORT & COMMUNITY
TPS22914B	<a href="#">Click here</a>	<a href="#">Click here</a>	<a href="#">Click here</a>	<a href="#">Click here</a>	<a href="#">Click here</a>
TPS22914C	<a href="#">Click here</a>	<a href="#">Click here</a>	<a href="#">Click here</a>	<a href="#">Click here</a>	<a href="#">Click here</a>
TPS22915B	<a href="#">Click here</a>	<a href="#">Click here</a>	<a href="#">Click here</a>	<a href="#">Click here</a>	<a href="#">Click here</a>
TPS22915C	<a href="#">Click here</a>	<a href="#">Click here</a>	<a href="#">Click here</a>	<a href="#">Click here</a>	<a href="#">Click here</a>

#### 13.3 Receiving Notification of Documentation Updates

To receive notification of documentation updates, navigate to the device product folder on [ti.com](#). Click on *Subscribe to updates* to register and receive a weekly digest of any product information that has changed. For change details, review the revision history included in any revised document.

#### 13.4 Support Resources

[TI E2E™ support forums](#) are an engineer's go-to source for fast, verified answers and design help — straight from the experts. Search existing answers or ask your own question to get the quick design help you need.

Linked content is provided "AS IS" by the respective contributors. They do not constitute TI specifications and do not necessarily reflect TI's views; see TI's [Terms of Use](#).

#### 13.5 Trademarks

Ultrabook™ is a trademark of Intel.

TI E2E™ is a trademark of Texas Instruments.

All other trademarks are the property of their respective owners.

#### 13.6 Electrostatic Discharge Caution



This integrated circuit can be damaged by ESD. Texas Instruments recommends that all integrated circuits be handled with appropriate precautions. Failure to observe proper handling and installation procedures can cause damage.

ESD damage can range from subtle performance degradation to complete device failure. Precision integrated circuits may be more susceptible to damage because very small parametric changes could cause the device not to meet its published specifications.

#### 13.7 Glossary

[TI Glossary](#) This glossary lists and explains terms, acronyms, and definitions.

## 14 Mechanical, Packaging, and Orderable Information

The following pages include mechanical, packaging, and orderable information. This information is the most current data available for the designated devices. This data is subject to change without notice and revision of this document. For browser-based versions of this data sheet, refer to the left-hand navigation.

**PACKAGING INFORMATION**

Orderable Device	Status (1)	Package Type	Package Drawing	Pins	Package Qty	Eco Plan (2)	Lead finish/ Ball material (6)	MSL Peak Temp (3)	Op Temp (°C)	Device Marking (4/5)	Samples
TPS22914BYFPR	ACTIVE	DSBGA	YFP	4	3000	RoHS & Green	SNAGCU	Level-1-260C-UNLIM	-40 to 105	S3	<a href="#">Samples</a>
TPS22914BYFPT	ACTIVE	DSBGA	YFP	4	250	RoHS & Green	SNAGCU	Level-1-260C-UNLIM	-40 to 105	S3	<a href="#">Samples</a>
TPS22914CYFPR	ACTIVE	DSBGA	YFP	4	3000	RoHS & Green	SNAGCU	Level-1-260C-UNLIM	-40 to 105	S6	<a href="#">Samples</a>
TPS22914CYFPT	ACTIVE	DSBGA	YFP	4	250	RoHS & Green	SNAGCU	Level-1-260C-UNLIM	-40 to 105	S6	<a href="#">Samples</a>
TPS22915BYFPR	ACTIVE	DSBGA	YFP	4	3000	RoHS & Green	SAC396   SNAGCU	Level-1-260C-UNLIM	-40 to 105	S4	<a href="#">Samples</a>
TPS22915BYFPT	ACTIVE	DSBGA	YFP	4	250	RoHS & Green	SAC396   SNAGCU	Level-1-260C-UNLIM	-40 to 105	S4	<a href="#">Samples</a>
TPS22915CYFPR	ACTIVE	DSBGA	YFP	4	3000	RoHS & Green	SNAGCU	Level-1-260C-UNLIM	-40 to 105	S7	<a href="#">Samples</a>
TPS22915CYFPT	ACTIVE	DSBGA	YFP	4	250	RoHS & Green	SNAGCU	Level-1-260C-UNLIM	-40 to 105	S7	<a href="#">Samples</a>

(1) The marketing status values are defined as follows:

**ACTIVE:** Product device recommended for new designs.

**LIFEBUY:** TI has announced that the device will be discontinued, and a lifetime-buy period is in effect.

**NRND:** Not recommended for new designs. Device is in production to support existing customers, but TI does not recommend using this part in a new design.

**PREVIEW:** Device has been announced but is not in production. Samples may or may not be available.

**OBSELETE:** TI has discontinued the production of the device.

(2) **RoHS:** TI defines "RoHS" to mean semiconductor products that are compliant with the current EU RoHS requirements for all 10 RoHS substances, including the requirement that RoHS substance do not exceed 0.1% by weight in homogeneous materials. Where designed to be soldered at high temperatures, "RoHS" products are suitable for use in specified lead-free processes. TI may reference these types of products as "Pb-Free".

**RoHS Exempt:** TI defines "RoHS Exempt" to mean products that contain lead but are compliant with EU RoHS pursuant to a specific EU RoHS exemption.

**Green:** TI defines "Green" to mean the content of Chlorine (Cl) and Bromine (Br) based flame retardants meet JS709B low halogen requirements of <=1000ppm threshold. Antimony trioxide based flame retardants must also meet the <=1000ppm threshold requirement.

(3) MSL, Peak Temp. - The Moisture Sensitivity Level rating according to the JEDEC industry standard classifications, and peak solder temperature.

(4) There may be additional marking, which relates to the logo, the lot trace code information, or the environmental category on the device.

(5) Multiple Device Markings will be inside parentheses. Only one Device Marking contained in parentheses and separated by a "~" will appear on a device. If a line is indented then it is a continuation of the previous line and the two combined represent the entire Device Marking for that device.

<sup>(6)</sup> Lead finish/Ball material - Orderable Devices may have multiple material finish options. Finish options are separated by a vertical ruled line. Lead finish/Ball material values may wrap to two lines if the finish value exceeds the maximum column width.

**Important Information and Disclaimer:**The information provided on this page represents TI's knowledge and belief as of the date that it is provided. TI bases its knowledge and belief on information provided by third parties, and makes no representation or warranty as to the accuracy of such information. Efforts are underway to better integrate information from third parties. TI has taken and continues to take reasonable steps to provide representative and accurate information but may not have conducted destructive testing or chemical analysis on incoming materials and chemicals. TI and TI suppliers consider certain information to be proprietary, and thus CAS numbers and other limited information may not be available for release.

In no event shall TI's liability arising out of such information exceed the total purchase price of the TI part(s) at issue in this document sold by TI to Customer on an annual basis.

**TAPE AND REEL INFORMATION**

**QUADRANT ASSIGNMENTS FOR PIN 1 ORIENTATION IN TAPE**

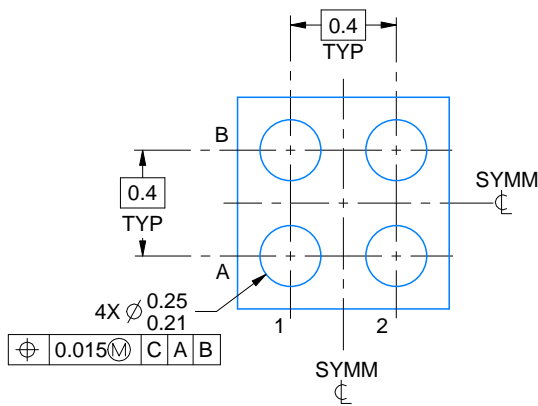
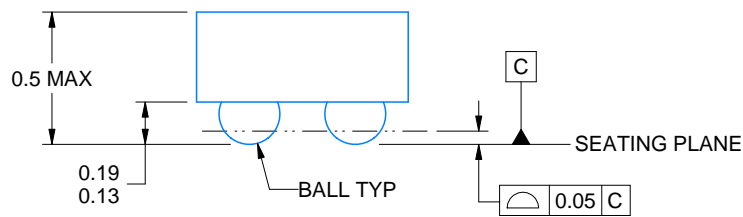
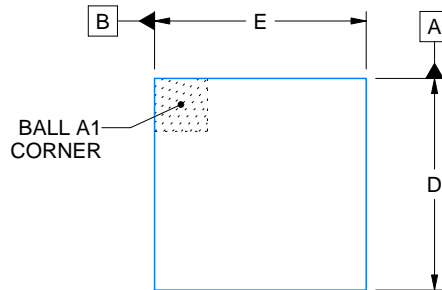

\*All dimensions are nominal

Device	Package Type	Package Drawing	Pins	SPQ	Reel Diameter (mm)	Reel Width W1 (mm)	A0 (mm)	B0 (mm)	K0 (mm)	P1 (mm)	W (mm)	Pin1 Quadrant
TPS22914BYFPR	DSBGA	YFP	4	3000	180.0	8.4	0.85	0.85	0.64	4.0	8.0	Q1
TPS22914BYFPR	DSBGA	YFP	4	3000	178.0	9.2	0.85	0.85	0.59	4.0	8.0	Q1
TPS22914BYFPT	DSBGA	YFP	4	250	178.0	9.2	0.85	0.85	0.59	4.0	8.0	Q1
TPS22914BYFPT	DSBGA	YFP	4	250	180.0	8.4	0.85	0.85	0.64	4.0	8.0	Q1
TPS22914CYFPR	DSBGA	YFP	4	3000	180.0	8.4	0.85	0.85	0.64	4.0	8.0	Q1
TPS22914CYFPT	DSBGA	YFP	4	250	180.0	8.4	0.85	0.85	0.64	4.0	8.0	Q1
TPS22915BYFPR	DSBGA	YFP	4	3000	180.0	8.4	0.85	0.85	0.64	4.0	8.0	Q1
TPS22915BYFPR	DSBGA	YFP	4	3000	178.0	9.2	0.85	0.85	0.59	4.0	8.0	Q1
TPS22915BYFPT	DSBGA	YFP	4	250	178.0	9.2	0.85	0.85	0.59	4.0	8.0	Q1
TPS22915BYFPT	DSBGA	YFP	4	250	180.0	8.4	0.85	0.85	0.64	4.0	8.0	Q1
TPS22915CYFPR	DSBGA	YFP	4	3000	180.0	8.4	0.85	0.85	0.64	4.0	8.0	Q1
TPS22915CYFPT	DSBGA	YFP	4	250	180.0	8.4	0.85	0.85	0.64	4.0	8.0	Q1

**TAPE AND REEL BOX DIMENSIONS**


\*All dimensions are nominal

Device	Package Type	Package Drawing	Pins	SPQ	Length (mm)	Width (mm)	Height (mm)
TPS22914BYFPR	DSBGA	YFP	4	3000	182.0	182.0	20.0
TPS22914BYFPR	DSBGA	YFP	4	3000	220.0	220.0	35.0
TPS22914BYFPT	DSBGA	YFP	4	250	220.0	220.0	35.0
TPS22914BYFPT	DSBGA	YFP	4	250	182.0	182.0	20.0
TPS22914CYFPR	DSBGA	YFP	4	3000	182.0	182.0	20.0
TPS22914CYFPT	DSBGA	YFP	4	250	182.0	182.0	20.0
TPS22915BYFPR	DSBGA	YFP	4	3000	182.0	182.0	20.0
TPS22915BYFPR	DSBGA	YFP	4	3000	220.0	220.0	35.0
TPS22915BYFPT	DSBGA	YFP	4	250	220.0	220.0	35.0
TPS22915BYFPT	DSBGA	YFP	4	250	182.0	182.0	20.0
TPS22915CYFPR	DSBGA	YFP	4	3000	182.0	182.0	20.0
TPS22915CYFPT	DSBGA	YFP	4	250	182.0	182.0	20.0



D: Max = 0.778 mm, Min = 0.718 mm  
 E: Max = 0.778 mm, Min = 0.718 mm

4223507/A 01/2017

NOTES:

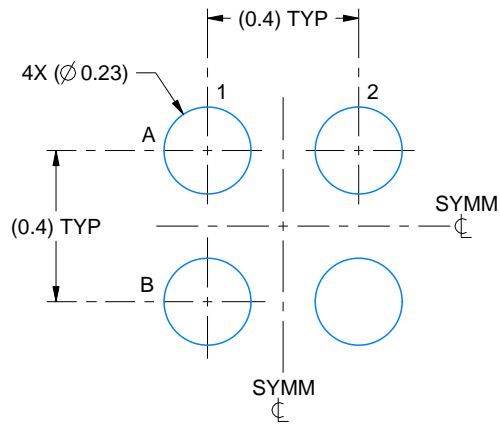
1. All linear dimensions are in millimeters. Any dimensions in parenthesis are for reference only. Dimensioning and tolerancing per ASME Y14.5M.
2. This drawing is subject to change without notice.

# EXAMPLE BOARD LAYOUT

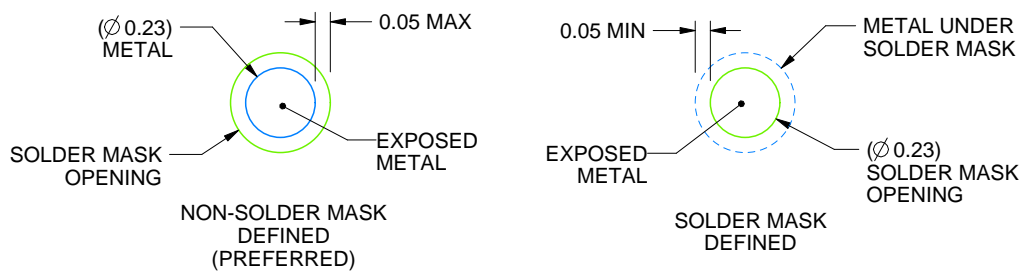
YFP0004

DSBGA - 0.5 mm max height

DIE SIZE BALL GRID ARRAY



LAND PATTERN EXAMPLE  
EXPOSED METAL SHOWN  
SCALE:50X



SOLDER MASK DETAILS  
NOT TO SCALE

4223507/A 01/2017

NOTES: (continued)

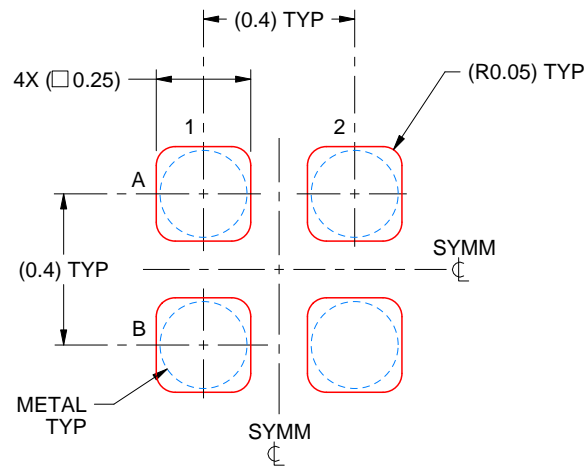
- Final dimensions may vary due to manufacturing tolerance considerations and also routing constraints. For more information, see Texas Instruments literature number SNVA009 ([www.ti.com/lit/snva009](http://www.ti.com/lit/snva009)).

# EXAMPLE STENCIL DESIGN

YFP0004

DSBGA - 0.5 mm max height

DIE SIZE BALL GRID ARRAY



SOLDER PASTE EXAMPLE  
BASED ON 0.1 mm THICK STENCIL  
SCALE:50X

4223507/A 01/2017

NOTES: (continued)

4. Laser cutting apertures with trapezoidal walls and rounded corners may offer better paste release.

## IMPORTANT NOTICE AND DISCLAIMER

TI PROVIDES TECHNICAL AND RELIABILITY DATA (INCLUDING DATASHEETS), DESIGN RESOURCES (INCLUDING REFERENCE DESIGNS), APPLICATION OR OTHER DESIGN ADVICE, WEB TOOLS, SAFETY INFORMATION, AND OTHER RESOURCES "AS IS" AND WITH ALL FAULTS, AND DISCLAIMS ALL WARRANTIES, EXPRESS AND IMPLIED, INCLUDING WITHOUT LIMITATION ANY IMPLIED WARRANTIES OF MERCHANTABILITY, FITNESS FOR A PARTICULAR PURPOSE OR NON-INFRINGEMENT OF THIRD PARTY INTELLECTUAL PROPERTY RIGHTS.

These resources are intended for skilled developers designing with TI products. You are solely responsible for (1) selecting the appropriate TI products for your application, (2) designing, validating and testing your application, and (3) ensuring your application meets applicable standards, and any other safety, security, or other requirements. These resources are subject to change without notice. TI grants you permission to use these resources only for development of an application that uses the TI products described in the resource. Other reproduction and display of these resources is prohibited. No license is granted to any other TI intellectual property right or to any third party intellectual property right. TI disclaims responsibility for, and you will fully indemnify TI and its representatives against, any claims, damages, costs, losses, and liabilities arising out of your use of these resources.

TI's products are provided subject to TI's Terms of Sale ([www.ti.com/legal/termsofsale.html](http://www.ti.com/legal/termsofsale.html)) or other applicable terms available either on [ti.com](http://ti.com) or provided in conjunction with such TI products. TI's provision of these resources does not expand or otherwise alter TI's applicable warranties or warranty disclaimers for TI products.

Mailing Address: Texas Instruments, Post Office Box 655303, Dallas, Texas 75265  
Copyright © 2020, Texas Instruments Incorporated